



OWNER'S MANUAL

www.camsuperline.com



Thank you for purchasing a CAM Superline trailer.

CAM Superline, Inc. manufactures durable, dependable dump trailers, construction trailers and pickup truck dump inserts.

Built for the long haul, CAM Superline trailers deliver consistent performance today and for years to come. Not only are you investing in a superior trailer, you're also backed by CAM's knowledgeable service network.

This manual is designed to provide information for you to safely understand, use, maintain and service your CAM Superline trailer.

It is essential that you read this manual prior to loading or towing your trailer and follow all safety precautions and instructions.

Visit us online at
www.camsuperline.com

Table of Contents

Safety Information

VIN Tag Information	1
Trailer Towing Guide Checklist	2
Make regular stops, about once each hour and confirm that:	2
Hazards From Modifying Your Trailer	3
Driving Too Fast	3
Failure To Adjust Handling While Towing a Trailer	3
Use An Adequate Tow Vehicle And Hitch	3
Securing the Safety Chains	3
Connecting the Electrical Cables	4
Attaching and Testing Electric Breakaway System	4
Incorrect Use of Breakaway System	5
Unsafe Tires, Lug Nuts, or Wheels	5
Overloading	6
Unsafe Load Distribution	6

Tire Safety Information

Tire Safety Tips	6
Tire Safety Checklist	7
Trailers 10,000 Pounds GVWR or Less	8
Trailers Over 10,000 Pounds GVWR	8
Safety First-Basic Tire Maintenance	8
Finding Your Vehicle's Recommended Tire Pressure and Load Limits	8
Checking Tire Pressure	9
Tire Size	9
Tire Tread	9
Tire Repair	9
Tire Fundamentals	9

Coupling to a Tow Vehicle

Coupling and Uncoupling the Trailer	10
Various Hitch Designs	10
Bumper Pull Trailers - Ball Coupler	10
Before Coupling the Trailer to the Tow Vehicle	11
Prepare the Ball Coupler and Hitch	11
Couple the Trailer to the Tow Vehicle	11
Bumper Pull Trailers - Pintle Ring	12
Before Coupling the Trailer to the Tow Vehicle	12
Prepare the Pintle Ring and Pintle Hook	12
Couple the Trailer to the Tow Vehicle	12
Uncoupling a Bumper Pull Trailer	13
Adjust Bumper Pull Trailer Hitch Height	13
Gooseneck Trailer with Ball Receiver	14
Before Coupling the Trailer to the Tow Vehicle	14
Prepare the Gooseneck Ball and Receiver	14
Couple the Trailer to the Tow Vehicle	15
Uncoupling Gooseneck Trailer with Ball Coupler	16
Adjust Gooseneck Coupler Height	17

Breaking in a New Trailer

Pre-Tow Checklist	18
Make Regular Stops	18
Re-tighten Lug Nuts at First 10, 25 & 50 Miles	18
Adjust Brake Shoes at First 200 Miles	18
Synchronizing the Brake Systems	19

Trailer Connection to a Tow Vehicle

Ball Coupler	19
Pintle Hook	19
Gooseneck	19
Fifth Wheel Kingpin	20
Landing Leg or Jack	20
Lights and Signals	20
Tires	20
Wheels	20
Wheels, Bearings and Lug Nuts	21
Electrical Connections - Construction Trailers	22
7 Way "RV Type Plug"	22
6 Way Round Plug	23
Electrical Connections - Dump Trailers	24
7 Way RV Type Plug	24
6 Way Round Plug	25

Hydraulics

Hydraulic Fluid and Reservoir	26
Problems Associated with the Reservoir	26
Trouble Shooting the Hydraulic System	26
Hydraulic Pump & Remote Diagrams	27

Loading & Unloading a Flatbed Trailer

Preparing the Trailer for Loading	28
Checking Tongue Weight	28
Tongue Weight	28
Loading Cargo	28
Securing the Cargo	29
Loading the Trailer	29
Ramp Types	30
Ladder or Wood Filled Ramps & Landscape Ramps	30

Loading & Unloading a Tilt Trailer

Loading and Unloading a Tilt Trailer	31
--	----

Loading & Unloading a Dump Trailer

Loading the Trailer	32
Slide-Out Ladder Ramps & Landscape Gate/Ramps	32
Hazards for Dump Trailers	33
Loading Fixed Loads	33
Rear Loading Equipment	34
Prepare Trailer for Loading	34
Loading and Unloading Bulk Materials	35
Loading Bulk Material	35
Unload Bulk Material Using the Spreader Gate	36

Unload Bulk Material Using the Split Barn Door & Combination Spreader/ Split Barn Door Gate	37
Hydraulic Reservoir & Components	38
Safety Prop	38
Securing the Cargo	39
Lubrication Points	39
Slide-Out Ramps	39

Accessories

Accessory Battery	39
Battery Charger/Maintainer	40
DC Hydraulic Power Unit	40

Inspection, Service & Maintenance

Inspection, Service & Maintenance Summary Charts	41
Axle Bolts, Frame, Suspension & Structure	43
Trailer Structure	43
Fasteners and Frame Members	43
Welds	43
Trailer Brakes - Electric	44
Brake Shoes & Drums	44
Manually Adjusting Brake Shoes	44
Brakes, Electric	44
Breakaway Brake	45
Tow Vehicle Operated Electric Brakes	45
Magnets for all Electric Brakes	45
Trailer Brakes - Surge	45
Surge Brake Master Cylinder	45
Hydraulic Surge Brakes	45
Master Cylinder Bleeding	46
Trailer Connection to Tow Vehicle	46
Bumper Pull Coupler & Ball	46
Pintle Ring & Hook	47
Gooseneck Ball Receiver	47
Landing Gear	47
Lights & Signals	47
Wheel	48
Tire Wear Diagnostic Chart	48
Wheel Bearings	49
Oil Bath Axles	50
Lug Nuts	50

Storage

Storage Preparation	51
After Prolonged Storage - Inspection Procedure	51
Trip Preparation Checklist	52
Maintenance Schedule	53

Warranty & Info

Limited Warranty	54
Reporting Safety Defects	55
Service Record	56-58

Safety Information

An owner's manual that provides general trailer information cannot cover all the specific details necessary for proper combination of every trailer, tow vehicle and hitch. Follow all of the safety precautions and instructions in this manual to ensure safety of persons, cargo and satisfactory life of the trailer. Therefore, you must read, understand and follow the instructions given by the tow vehicle and trailer hitch manufacturers.

Loss of control of the trailer or trailer/tow vehicle combination can result in serious injury or death. The most common causes for loss of control of the trailer are:

- Driving too fast for the conditions
- Inadequate tow vehicle or towing hitch
- Trailer improperly coupled to the hitch
- Overloading the trailer or loading the trailer unevenly
- No braking on the trailer
- Not maintaining proper tire pressure
- Not maintaining proper lug nut torque
- Not properly maintaining the trailer structure

Vin Tag Information

The trailer "VIN Tag" or Vehicle Identification Number, is located on the front driver's side of the trailer. The "VIN Tag" contains the following critical safety information for the use of your trailer.

GAWR: The maximum gross weight that an axle can support. It is the lowest of the axle, wheel or tire rating.

GVWR: The maximum allowable gross weight of the trailer and its contents. The gross weight of the trailer includes the weight of the trailer and all of the items on it, such as cargo.

PSI: The tire pressure (Pounds per Square Inch)

Empty Weight: Some information that comes with the trailer (such as the Manufacturer's Statement of Origin) is not a reliable source for "empty" weight. The shipping documents list standard weights and your trailer may be equipped with options. To determine the "empty" weight of your trailer, weigh it on an axle scale. To find the weight of the trailer using an axle scale, you must know the axle weights of your tow vehicle without the trailer coupled. Some of the trailer weight will be transferred from the trailer to the tow vehicle axles and an axle scale weighs all axles, including the tow vehicle axles.

Trailer Towing Guide Checklist

Driving a vehicle with a trailer in tow is vastly different from driving the same vehicle without a trailer in tow. Acceleration, maneuverability and braking are all diminished with a trailer in tow.

- ✓ Recheck the load tie downs to make sure the load will not shift during towing.
- ✓ Before towing, check coupling, safety chains, breakaway system, tires, wheels and lights
- ✓ Check lug nut torque
- ✓ Check coupler or pintle tightness after towing 50 miles.
- ✓ Adjust the brake controller to engage the trailer brakes before the tow vehicle brakes. Your dealer can assist you by making this adjustment.
- ✓ Use your mirrors to verify that you have room to change lanes or pull into traffic.
- ✓ Use your turn signals well in advance.
- ✓ Allow plenty of stopping space for your trailer and tow vehicle.
- ✓ Do not drive so fast that the trailer begins to sway due to excess speed.
- ✓ Allow plenty of room for passing. A rule of thumb is that the passing distance with a trailer is 4 times the passing distance without a trailer.
- ✓ Shift your automatic transmission into a lower gear for city driving.
- ✓ Use lower gears for climbing and descending grades.
- ✓ Do not ride the brakes while descending grades; they may get so hot that they stop working. Then you will potentially have a runaway tow vehicle and trailer.
- ✓ To conserve fuel, don't use full throttle to climb a hill. Instead, build speed on the approach.
- ✓ Slow down for bumps in the road. Take your foot off the brake when crossing the bump.
- ✓ Do not brake while in a curve unless absolutely necessary. Instead, slow down before you enter the curve and power throughout the curve. This way, the towing vehicle remains "in charge"
- ✓ Do not apply the brakes to correct extreme trailer swaying. Continued pulling of the trailer and even slight acceleration will provide a stabilizing force.

Make regular stops, about once each hour and confirm that:

- ✓ The coupler is secure to the hitch and is locked.
- ✓ Electrical connectors are made.
- ✓ There is appropriate slack in the safety chains and breakaway switch cable.
- ✓ The tires are not visibly low on pressure.
- ✓ The cargo is secure and in good condition.

Hazards From Modifying Your Trailer

Essential safety items can be damaged by altering your trailer. Before making any alteration to your trailer, contact your dealer. Structural modifications will void your warranty.

CAUTION

Driving too fast for conditions can result in loss of control and cause serious injury or death.

Driving Too Fast

With ideal road conditions, the maximum speed when safely towing a trailer is 60 M.P.H.

Failure To Adjust Handling While Towing a Trailer

When towing a trailer, you will have decreased acceleration, increased stopping distance and increased turning radius. In addition, you will need a longer distance to pass, due to slower acceleration and increased length.

- Anticipate the trailer swaying. Swaying is the trailer's reaction to the air pressure wave caused by passing trucks and buses. Continued pulling of the trailer provides a stabilizing force to correct swaying. Do not apply the brakes to correct trailer swaying.
- Use a lower gear when driving down steep or long grades. Use the engine and transmission as a brake. Do not ride the brakes, as they can overheat and become ineffective.

Use An Adequate Tow Vehicle And Hitch

If the vehicle or hitch is not properly selected and matched to the GVWR of your trailer, you can cause an accident that could lead to serious injury or death.

If you already have a tow vehicle, know your vehicle tow rating and make certain the trailer's rated capacity is less than or equal to the tow vehicle's rated towing capacity. If you already have a trailer, make certain that the tow rating of the tow vehicle is equal to or greater than that of the trailer.

Securing the Safety Chains

- Visually inspect the safety chains and hooks for wear or damage. Replace worn or damaged safety chains and hooks before towing.
- Secure the safety chains so that they:
 - Criss-cross underneath the hitch with enough slack to permit turning and to hold the tongue up above the ground if the trailer comes loose.
 - Secure the safety chains to the frame of the tow vehicle. Do not secure the safety chains to the interchangeable part of the hitch assembly.

CAUTION

Improperly attached safety chains can result in loss of control of the trailer and tow vehicle. This can result in serious injury or death if the trailer unhooks from the tow vehicle.

Connecting the Electrical Cables

Connect the trailer lights to the tow vehicle's electrical system using the electrical connectors. Be sure that the electric brakes and all of the lights on your trailer are functioning properly before towing the trailer. The electric brakes and lights on a trailer are controlled by a connection to the tow vehicle.

If the trailer has electric brakes, your tow vehicle should have an electric brake controller that sends power to the trailer brakes. Before towing the trailer on the road, you must operate the brake controller while trying to pull the trailer in order to confirm that the electric brakes operate. While towing the trailer at less than 5mph, manually operate the electric brake controller in the tow vehicle cab.

You should feel the operation of the trailer brakes.

CAUTION

Improper electrical connection between the tow vehicle and the trailer will result in inoperable lights and electric brakes, and can lead to collision.

Before each tow, check:

- All lights and turn signals work.
- The electric brakes work by operating the brake controller inside the tow vehicle.

Attaching and Testing Electric Breakaway System

If the ball coupler, pintle, or hitch fails, a properly connected and working breakaway system will apply electric brakes on the trailer.

The breakaway brake system may be fitted with a charging facility that draws power from the tow vehicle. If the electrical system on your tow vehicle does not provide power to the breakaway battery, you must periodically charge the battery to keep the breakaway brake system in working order.

CAUTION

Disconnect the trailer plug before testing breakaway unit. Failure to do so will result in severe damage to electric brake control.

- Connect the breakaway cable to the tow vehicle so that the cable will be pulled out before all of the slack in the safety chains are taken up. Do not connect the cable to the safety chain or any part of the hitch. This would keep the breakaway system from operating when needed.
- Remove the cable pin from the switch and test tow the trailer, at less than 5 mph. You should feel the trailer resisting being towed, but the wheels will not necessarily be locked. If the brakes do not function, do not tow the trailer until the brakes are repaired.
- Immediately replace the cable pin. The breakaway system battery will discharge rapidly when the cable pin is removed.

Incorrect Use of Breakaway System

Do not tow the trailer with the breakaway system ON because the brakes will overheat which can result in permanent brake failure. Do not use the breakaway system as a parking brake.

If you do not use the trailer for three or more months, or during winter months:

- Store the battery indoors.
- Charge the battery every three months.

CAUTION

An ineffective or inoperative breakaway system can result in a runaway trailer, leading to serious injury or death. Before towing the trailer, test the function of the breakaway system. If the breakaway system is not working, do not tow the trailer; have it serviced or repaired.

Unsafe Tires, Lug Nuts, or Wheels

It is essential to inspect the trailer tires before each tow.

Improper tire pressure causes an unstable trailer and can result in a tire blowout and loss of control. Therefore, before each tow you must check tire pressure. Tire pressure must be checked when tires are cold. Allow three hours for tires to cool down after driving before checking tire pressure. NOTE: Trailer tires may require higher pressures than passenger vehicle tires.

CAUTION

Improper tire pressure can result in a blowout and loss of control, which can lead to serious injury or death.

Be sure tires are inflated to pressure indicated on side wall before towing trailer.

Since trailer wheels and lug nuts are subjected to greater side loads than automobile wheels, they are more prone to loosen. Before each tow, check to make sure they are tight. Lug nuts are prone to loosen after first being assembled.

When driving a new trailer (or after wheels have been remounted), check to make sure the lug nuts are tight and re-torque after the first 10, 25, and 50 miles of driving and before each tow thereafter. Improper lug nut torque can cause a wheel to part from the trailer. Either of these can lead to serious injury or death.

The proper tightness (torque) for lug nuts are listed here. Use a torque wrench to tighten the lug nuts. If you do not have a torque wrench, use a lug wrench and tighten the lug nuts as much as you can. Then have a service

Lug Nut Torque - Steel Wheels

Axle Rating (Lbs.)	Stud Size	Torque - Ft. Lbs.
3,500	1/2 inch	90 to 120
6,000 6 Lug	1/2 inch	90 to 120
6,000 & 7,000 8 Lug	9/16 inch	90 to 120
8,000	5/8 in. flanged	275 to 325
10,000	5/8 inch	190 to 210
12,000	5/8 inch	190 to 210
22,500	M22 x 1.5 Swivel Flange	450 to 500

garage or trailer dealer tighten the lug nuts to the proper torque.

Overloading

The total weight of the load you put in or on the trailer, plus the empty weight of the trailer itself, must not exceed the trailer's Gross Vehicle Weight Rating (GVWR). If you do not know the empty weight of the trailer, you must weigh it at a commercial scale. In addition, you must distribute the load on the trailer in such a way that the

CAUTION

An overloaded trailer can result in loss of control of the trailer, leading to serious injury or death.

load on any tire or axle does not exceed the tire load rating or the Gross Axle Weight Rating (GAWR).

Unsafe Load Distribution

Uneven load distribution can cause tire, wheel, axle, or structural failure. Be sure your trailer is properly loaded. Improper front / rear load distribution can lead to an unstable trailer or poor tow vehicle handling.

A proper weight distribution is equal, right to left and creates a tongue weight that is in the proper range for stable trailer handling. For tandem and triple axle trailers it is necessary to know or check that no axle is overloaded.

In the table below, the second column notes the rule of thumb percentage of total weight of the trailer plus its cargo (Gross Vehicle Weight) that should appear on the tongue of the trailer. For example, a trailer with a gooseneck hitch, with a loaded weight of 12,000 lbs., should have 20-25% of 12,000 lbs. on the tongue (2,400 to 3,000 lbs.).

Tongue weight as a percentage of loaded trailer weight

Type of Hitch	Percentage
Bumper Hitch	10-15%
Gooseneck Hitch	20-25%
Fifth Wheel Hitch	20-25%

Towing stability also depends on keeping the center of gravity as low as possible. Load heavy items on the floor and over the axles, but do not exceed the axle load rating

CAUTION

Improper load distribution can result in loss of control of the trailer, leading to serious injury or death.

(GAWR). When loading additional items, be sure to maintain even side-to-side weight distribution and proper tongue weight.

Tire Safety Tips

Preventing Tire Damage

- Slow down if you have to go over a pothole or other objects in the road.
- Do not run over curbs or other foreign objects in the roadway, and try not to strike the curb when parking.

Tire Safety Information

The portion of the User's Manual contains tire safety required by 49 CFR 575.6.

Trailer tires may be worn out, even though they still have plenty of tread left. This is because trailer tires have to carry a lot of weight all the time, even when not in use. It is actually better for the tire to be rolling down the road than to be idle. During use, the tire releases lubricants that are beneficial to tire life. Using the trailer tires often helps prevent flat spots from developing.

Determining the load limits of a trailer includes more than understanding the load limits of the tires alone. On all trailers there is a Federal Certification / VIN label that is located on the forward half of the left (road) side of the unit. This certification / VIN label will indicate the trailer's Gross Vehicle Weight Rating (GVWR). This is the most weight the fully loaded trailer can weigh. It will also provide the Gross Axle Weight Rating (GAWR). This is the most a particular axle can weigh. If there are multiple axles, the GAWR of each axle will be provided.

If your trailer has a GVWR of 10,000 pounds or less, there is a vehicle placard located in the same location as the certification label described above. This placard provides tire and loading information. In addition, this placard will show a statement regarding maximum cargo capacity. Cargo can be added to the trailer, up to the maximum weight specified on the placard. The combined weight of the cargo is provided as a single number. In any case, remember; the total weight of a fully loaded trailer can not exceed the stated GVWR.

When loading your cargo, be sure it is distributed evenly to prevent overloading front to back and side to side. Heavy items should be placed low and as close to the axle positions as reasonable. Too many items on one side may overload a tire. The best way to know the actual weight of the trailer is to weigh it at a public scale. Talk to your dealer to discuss the weighing methods needed to capture the various weights related to the trailer. This would include the weight empty or unloaded, weights per axle, wheel, hitch or king-pin, and total weight.

Excessive loads and/or under inflation cause tire overloading and, as a result, abnormal tire flexing occurs. This situation can generate an excessive amount of heat within the tire. Excessive heat may lead to tire failure. It is the air pressure that enables a tire to support the load, so proper inflation is critical. The proper air pressure may be found on the Certification / VIN label and/or on the tire placard. This value should never exceed the maximum cold inflation pressure stamped on the tire.

Tire Safety Checklist

- ✓ Check tire pressure regularly (at least once a month), including the spare.
- ✓ Inspect tires for uneven wear patterns on the tread, cracks, foreign objects or other signs of wear or trauma.
- ✓ Make sure your tire valves have valve caps.
- ✓ Check tire pressure before going on a long trip.
- ✓ Do not overload your vehicle. Check the Tire Information and Loading
- ✓ Placard or User's Manual for the maximum recommended load for the vehicle.

Trailers 10,000 Pounds GVWR or Less

• Locate the statement, “The weight of cargo should never exceed XXX KG or XXX lbs.,” on your vehicle’s placard. See Figure 1-1.

TIRE AND LOADING INFORMATION		
The weight of cargo should never exceed XXX kg. or XXX lbs.		
TIRE	SIZE	COLD TIRE PRESSURE
FRONT	20.5x8.0-10(E)	621KPA, 90PSI
REAR		
SPARE		

SEE OWNER'S MANUAL FOR ADDITIONAL INFORMATION

- This figure equals the available amount of cargo and luggage load capacity.
- Determine the combined weight of luggage and cargo being loaded on the vehicle. That weight may not safely exceed the available cargo and luggage load capacity.
- Subtract the empty weight of your trailer from the GVWR stated on the VIN label. That weight is the maximum available cargo capacity of the trailer and may not be safely exceeded.

The trailer’s placard refers to the Tire Information Placard attached adjacent to or near the trailer’s VIN (certification) label at the left front of the trailer.

The National Traffic Safety Administration (NHTSA) has published a brochure (DOT HS 809 361) that discusses all aspects of tire safety, as required by CFR 575.6. This brochure is reproduced in part below. It can be obtained and downloaded from NHTSA, free of charge, from the following website:

http://www.nhtsa.dot.gov/cars/rules/TireSafety/ridesonit/tires_index.html

Trailers Over 10,000 Pounds GVWR

(NOTE: These trailers are not required to have a tire information placard on the trailer and may not have one installed)

Safety First-Basic Tire Maintenance

Properly maintained tires improve the steering, stopping, traction, and load-carrying capability of your vehicle. Under-inflated tires and overloaded vehicles are a major cause of tire failure. Therefore, as mentioned above, to avoid flat tires and other types of tire failure, you should maintain proper tire pressure, observe tire and vehicle load limits, avoid road hazards and regularly inspect your tires.

Finding Your Vehicle’s Recommended Tire Pressure and Load Limits

Tire information placards and vehicle certification labels contain information on tires and load limits. These labels indicate vehicle manufacturer’s information including:

- Recommended tire size.
- Recommended tire inflation pressure.
- Vehicle capacity weight (VCW - the maximum cargo weight a vehicle is designed to carry).
- Front and rear gross axle weight ratings (GAWR - the maximum weight the front axle systems are designed to carry).

Checking Tire Pressure

It is important to check your vehicle's tire pressure at least once a month for the following reasons:

- Most tires may naturally lose air over time.
- Tires can lose air suddenly if you drive over a pothole or other object or if you strike the curb when parking.
- With radial tires, it is usually not possible to determine under-inflation by visual inspection.

For convenience, purchase a tire pressure gauge to keep in your vehicle. The recommended tire inflation pressure that vehicle manufacturers provide reflects the proper psi when a tire is cold. The term cold does not relate to the outside temperature. Rather, a cold tire is one that has not been driven on for at least three hours. When you drive, your tires get warmer, causing the air pressure within them to increase. To get an accurate reading, measure tire pressure when the tires are cold or compensate for the extra pressure in warm tires.

Tire Size

To maintain tire safety, purchase new tires that are the same size as the vehicle's original tires or another size recommended by the manufacturer. Look at the tire information placard, the owner's manual or the sidewall of the tire to find this information. If you have any doubt about the correct size to choose, consult with the tire dealer.

Tire Tread

The tire tread provides the gripping action and traction that prevent your vehicle from slipping or sliding, especially when the road is wet or icy. In general, tires are not safe and should be replaced when the tread is worn down to 1/16 of an inch. Tires have built-in treadwear indicators that let you know when it is time to replace your tires. These indicators are raised sections spaced intermittently in the bottom of the tread grooves. When they appear "even" with the outside of the tread, it is time to replace your tires.

Tire Repair

The proper repair of a punctured tire requires a plug for the hole and a patch for the area inside the tire that surrounds the puncture hold. Punctures through the tread can be repaired if they are not too large, but punctures to the sidewall should not be repaired. Tires must be removed from the rim to be properly inspected before being plugged and patched.

Tire Fundamentals

Federal law requires tire manufacturers to place standardized information on the sidewall of all tires. This information identifies and describes the fundamental characteristics of the tire and also provides a tire identification number for safety standard certification and in case of a recall.

Coupling and Uncoupling the Trailer

A secure coupling of the trailer to the tow vehicle is essential. A loss of coupling may result in serious injury or death. Therefore, you must understand and follow all of the instructions. The following parts are involved in making a secure coupling between the trailer and the tow vehicle:

- **Ball Coupler or Pintle** - Device on the tongue of the trailer that connects the hitch on the tow vehicle.
- **Hitch** - Device on the tow vehicle that supports the weight of the trailer tongue and pulls the trailer. The ball coupler or pintle attaches to the hitch.
- **Safety Chains** - If the coupler connection comes loose, the safety chains can keep the trailer attached to the tow vehicle. With properly rigged safety chains, it is possible to keep the tongue of the trailer from digging into the road pavement, even if the ball coupler or pintle to hitch connection comes apart.
- **Breakaway Switch** - If the coupler connection comes loose, the breakaway switch can actuate emergency electrical brakes on the trailer. The breakaway switch must be rigged to the tow vehicle with appropriate slack that will activate the switch if the coupler connection comes loose.
- **Jack** - Device on the trailer that is used to raise and lower the hitch. The jack is also referred to as the “landing gear”.

Various Hitch Designs

Trailers are produced with a variety of hitch devices. One of the following sections will pertain to your trailer.

- Bumper pull; ball coupler or pintle ring
- Gooseneck ball coupler
- Gooseneck fifth wheel or king pin coupler



Bumper Pull Trailers - Ball Coupler

A ball coupler connects to a ball that is located on or under the rear bumper of the tow vehicle. This system of coupling a trailer to a tow vehicle is sometimes referred to as “bumper pull”. We have utilized a ball coupler that is suitable for the size and weight of the trailer. You must provide a hitch and ball for your tow vehicle, where the load rating of the hitch and ball is equal to or greater than that of your trailer. Also, the ball size must be the same as the coupler size. The ball size and load rating (capacity) are marked on the ball; hitch capacity is marked on the hitch. If the hitch ball is too small, too large, is underrated, is loose or is worn, the trailer can come loose from the tow vehicle, and may cause serious injury or death.

Your trailer may be equipped with a Hydraulic Surge Brake Actuator. Surge braking is accomplished with an actuator and hydraulic brake assemblies. The “surge” or “push” of the trailer toward the tow vehicle during deceleration automatically synchronizes these trailer brakes with the tow vehicle brakes. As the trailer pushes against the vehicle, the actuator telescopes together and applies force to its master cylinder, supplying hydraulic pressure to the trailer’s brakes. For more information, refer to the Brake Actuator manual provided with your trailer.

Before Coupling the Trailer to the Tow Vehicle

Be sure the size and rating of the hitch ball match the size and rating of the ball coupler. Hitch balls and ball couplers are marked with their size and ratings.

- Wipe the hitch ball clean and inspect it visually and feel for flat spots, cracks and pits.
- Rock the ball to make sure it is tight to the hitch, and visually check that the hitch ball nut is solid against the lock washer and hitch frame.
- Wipe the inside and outside of the coupler clean and inspect it visually for cracks and deformations; feel the inside of the coupler for worn spots and pits.
- Be sure the coupler is tight to the tongue of the trailer. All ball coupler fasteners must be visibly solid against the trailer frame.
- Raise the bottom surface of the coupler to be above the top of the hitch ball.

CAUTION

Ball coupler-to-hitch mismatch can result in uncoupling, leading to serious injury or death. Be sure the LOAD RATING of the hitch ball is equal or greater than the load rating of the ball coupler. Be sure the SIZE of the hitch ball matches the size of the ball coupler.

Prepare the Ball Coupler and Hitch

- Lubricate the hitch ball and the inside of the ball coupler with a thin layer of automotive bearing grease.
- Remove the safety latch pin and open the coupler locking mechanism.
- In the open position, the coupler is able to drop fully onto the hitch ball.
- See the ball coupler instructions for details of placing the ball coupler in the “open” position.
- Slowly back up the tow vehicle so that the hitch ball is near or aligned under the ball coupler.

Couple the Trailer to the Tow Vehicle

- Lower the trailer tongue until the coupler fully engages the hitch ball. If the ball coupler does not line up with the hitch ball adjust the position of the tow vehicle.
- Engage the ball coupler locking mechanism. In the engaged position, the locking mechanism securely holds the ball coupler to the hitch ball.
- Insert the safety lock pin through the hole in the locking mechanism.
- Be sure the ball coupler is all the way on the hitch ball and the locking mechanism is engaged. A properly engaged locking mechanism will allow the coupler to raise the rear of the tow vehicle. Using the trailer jack, test to see that you can raise the rear of the tow vehicle by one inch, after the coupler is locked to the hitch.

Note: The tongue jack can be damaged by overloading. Do not use the tongue jack to raise the tow vehicle more than one inch.

If the coupler cannot be secured to the hitch ball, do not tow the trailer. Contact your dealer for assistance.

- Lower the trailer so that its entire tongue weight is held by the hitch, and continue retracting the jack to its fully retracted position
- Fully retract jack drop leg and insert pin.

Bumper Pull Trailers - Pintle Ring

We have utilized a pintle ring that is suitable for the size and weight of the trailer. The load rating of the ring and the necessary pintle size are listed on the trailer tongue. You must provide a pintle for your tow vehicle, where the load rating of the hitch and pintle is equal to or greater than that of your trailer. Also, the pintle size must be the same as the ring size. If the pintle is too small, too large, is underrated, is loose or is worn, the trailer can come loose from the tow vehicle, and cause serious injury or death. **The tow vehicle, hitch, and pintle must have a rated towing capacity equal to or greater than the trailer GVWR.**

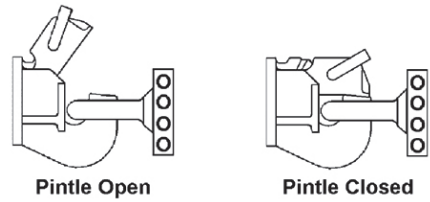

Before Coupling the Trailer to the Tow Vehicle

Be sure the size and rating of the pintle match the size and rating of the pintle ring. Pintle ring and pintle hooks are marked with their size and ratings.

- Wipe the pintle clean and inspect it visually and feel for flat spots, cracks and pits.
- Rock the pintle to make sure it is tight to the hitch, and visually check that the pintle fasteners are solid against the lock washer and hitch frame.
- Wipe the inside and outside of the pintle ring clean and inspect it visually for cracks and deformations; feel the inside of the pintle ring for worn spots and pits.
- Be sure the pintle ring is tight to the tongue of the trailer. All pintle ring fasteners must be visibly solid against the trailer frame.
- Raise the bottom surface of the pintle ring to be above the top of the open pintle.

Prepare the Pintle Ring and Pintle Hook

- Lubricate the inside of the pintle with a thin layer of automotive bearing grease.
- Remove the safety latch pin and open the pintle locking mechanism.
- In the open position, the ring is able to drop fully onto the pintle.
- Slowly back up the tow vehicle so that the pintle is near or aligned under the pintle ring.

Couple the Trailer to the Tow Vehicle

- Lower the trailer tongue until the pintle ring fully engages the pintle. If the ring does not line up with the pintle adjust the position of the tow vehicle.
- Engage the pintle locking mechanism. In the engaged position, the locking mechanism securely holds the pintle ring to the pintle.
- Insert the safety lock pin through the hole in the locking mechanism.
- Be sure the pintle ring is all the way on the pintle and the locking mechanism is engaged. A properly engaged locking mechanism will allow the pintle to raise the rear of the tow vehicle. Using the trailer jack, test to see that you can raise the rear of the tow vehicle by one inch, after the coupler is locked to the hitch.

If the pintle hook cannot be secured to the hitch ball, do not tow the trailer. Contact your dealer for assistance.

- Lower the trailer so that its entire tongue weight is held by the hitch, and continue retracting the jack to its fully retracted position
- Fully retract jack drop leg and insert pin.

Uncoupling a Bumper Pull Trailer

Follow these steps to uncouple your bumper hitched trailer from the tow vehicle:

- ✓ Park the trailer on a firm level surface and block trailer tires.
- ✓ Disconnect the electrical connector.
- ✓ Disconnect the breakaway brake switch lanyard.
- ✓ Disconnect the safety chains from the tow vehicle.
- ✓ Unlock the coupler and open it.
- ✓ Before extending the jack, make certain the ground surface below the jack pad will support the tongue load.
- ✓ Rotate the jack handle to extend the jack and transfer the weight of the trailer tongue to the jack.
- ✓ Raise the trailer ball coupler or pintle above the tow vehicle hitch.

Adjust Bumper Pull Trailer Hitch Height

The height of the hitch on the trailer must be adjusted so that the trailer, when loaded to rated capacity, is level while connected to the tow vehicle. A level trailer allows equal weight distribution on the axles. Your dealer or a trailer service center can perform this adjustment or you can use the following steps to adjust the hitch height yourself.

- Connect trailer to tow vehicle and load the trailer to rated capacity.
- Park the tow vehicle and trailer on a firm level surface. If the front of the trailer is higher than the rear, the hitch must be raised. If the front of the trailer is lower than the rear, the hitch must be lowered.
- Uncouple trailer from tow vehicle.
- Remove the lock nuts and bolts on hitch. Discard locknuts. Inspect bolts for damage and replace if necessary. Contact your dealer for correct size and grade of bolts.
- Raise or lower the hitch as necessary.
- Install bolts and new lock nuts. Tighten lock nuts to 100 lb/ft of torque.
- Couple the trailer to the tow vehicle and verify that the trailer is level.
- Unload trailer and disconnect from tow vehicle.

CAUTION

Improper hitch height adjustment can result in overloaded tires, blowout and loss of control, leading to serious injury or death.

Adjust the hitch height so that the loaded trailer is level.

Gooseneck Trailer with Ball Receiver

A gooseneck ball receiver on the trailer connects to a gooseneck ball that you must have installed in the bed of the tow vehicle.

We have installed a receiver that is suitable for the size and weight of the trailer. The load rating of the coupler and the necessary ball size are listed on the gooseneck. You must provide a gooseneck ball and support structure that is marked with a rating that meets or exceeds the GVWR of your trailer and matches the size of the gooseneck ball receiver. If the gooseneck coupler is too small, too large, is underrated, is loose or is worn, the trailer can come loose from the tow vehicle, and cause serious injury or death.

The tow vehicle, support structure, and gooseneck ball must have a rated towing capacity equal to or greater than the trailer GVWR.

CAUTION

Coupler-to-hitch mismatch can result in uncoupling, leading to serious injury or death. Be sure the **LOAD RATING** of the hitch ball is equal or greater than the load rating of the ball coupler. Be sure the **SIZE** of the hitch ball matches the size of the coupler.

Before Coupling the Trailer to the Tow Vehicle

- Be sure the size and rating of the gooseneck ball match the size and rating of the receiver.
- Wipe the gooseneck ball clean and inspect it visually and feel for flat spots, cracks, and pits.
- Rock the ball to make sure it is tight to the hitch, and visually check that the gooseneck fasteners are solid against the lock washer and ball support frame.
- Wipe the inside and outside of the receiver clean and inspect it visually for cracks and deformations; feel the inside of the receiver for worn spots and pits. If any of these conditions exist, have the receiver replaced before coupling the trailer
- Be sure the receiver is tight to the trailer. All receiver fasteners must be visibly solid against the trailer frame.
- Release the jack handle or crank from its holder.
- Rotate the handle/crank clockwise to raise the bottom surface of the gooseneck to be above the top of the gooseneck ball.

Prepare the Gooseneck Ball and Receiver

- Release the lock plate on the gooseneck ball receiver. With the spring-loaded lock plate locking pin in the open position, rotate the lock plate to a position that allows the gooseneck ball to enter the receiver.
- Slowly back up the tow vehicle so that the ball is aligned under the receiver.

Couple the Trailer to the Tow Vehicle

- Rotate the jack handle counter-clockwise. This will retract the jack causing the receiver to drop down so it can fully engage the ball and transfer the weight of the trailer tongue to the towing vehicle hitch. If the receiver does not line up with the ball, raise the receiver again and adjust the position of the tow vehicle. Then lower the receiver over the ball. When the drop leg base is no longer resting on the ground, the towing vehicle hitch is holding all of the weight of the trailer tongue.
- Close the lock plate on the receiver.
- Move the spring-loaded lock plate locking pin to the closed position. Be sure the locking pin is holding the lock plate.
- Be sure the receiver is all the way on the ball and the lock plate is engaged. A properly engaged locking mechanism will allow the coupler to raise the rear of the tow vehicle. Using the trailer jack, test to see that you can raise the rear of the tow vehicle by one inch.

If the receiver cannot be secured to the ball, do not tow the trailer. Contact your dealer for assistance.

After testing to see that the receiver is properly secured and locked to the ball, retract the jack to its fully retracted position.

- Return the drop leg(s) to their upper positions. The drop leg(s) are held in the lowered position with a pin. Rotating the pin while pulling it outward will cause it to come out of engagement with the drop leg and the leg will rapidly rise.

Uncoupling Gooseneck Trailer with Ball Coupler

Follow these steps to uncouple your gooseneck hitch trailer from the tow vehicle:

- Park the trailer on a firm level surface.
- Block trailer tires to prevent the trailer from rolling, before jacking the trailer.
- Lower the tow vehicle tailgate.
- Disconnect the electrical connector.
- Disconnect the breakaway switch cable.
- Disconnect the safety chains from the tow vehicle.
- Move the spring-loaded receiver lock plate locking pin to the open position.
- Rotate the lock plate to a position that permits the gooseneck ball to exit the receiver.
- Before releasing the drop leg jack, make certain ground surface below jack base will support the trailer tongue load.
- Rotate the drop leg pin handle so that the pin is released from the drop leg.
- Push down on the drop leg base with your foot to place a drop leg to the desired lowered position.
- Rotate the pin handle so that the pin is attempting to engage the drop leg.
- Slowly raise your foot, permitting the drop leg to rise. The pin will engage a hole in the drop leg.
- Be sure the pin is fully engaged. Push it in by hand if necessary. The bent part of the pin handle must be touching the pin housing.
- If your trailer has two drop leg jacks, lower them both to the same level.

Note: If the drop legs are not set at the same level, one of the drop leg jacks can be overloaded and can be damaged.

CAUTION

The drop legs are heavily spring loaded in the lowered position. They will rapidly return to the upper position when released and can inflict serious injuries.

Keep your feet, shins and hands well clear of the drop legs and drop leg bases when releasing the drop legs.

- Release the handle from its holder and engage it with the jackshaft.
- Rotate the handle (or crank) clockwise to slowly extend the jack and transfer the weight of the trailer tongue to the jack.
- Continue to extend the jack(s), making sure that the ground is providing stable and level support for the trailer.
- After the jack(s) are extended and the gooseneck ball receiver is well clear of the gooseneck ball, to permit driving the tow vehicle away, disengage the handle from its shaft and return to its holder.

Adjust Gooseneck Coupler Height

The height of the ball receiver on the trailer must be adjusted so that the trailer, when loaded to rated capacity, is level while connected to the tow vehicle. A level trailer allows equal weight distribution on the axles. There must also be adequate clearance between the bottom of the trailer and the sides of the tow vehicle bed.

Connect trailer to tow vehicle and load the trailer to rated capacity. Park the vehicle and trailer on a firm level surface.

Stand back from the trailer and visually verify if the trailer is level front-to-rear. If the front of the trailer is higher than the rear, the hitch must be retracted. If the front of the trailer is lower than the rear, the hitch must be extended. Uncouple trailer from tow vehicle.

Loosen the jam nut and setscrew (1). Remove safety lock pin (2) and load bearing pin (3). Extend or retract the receiver as needed. The maximum the receiver can be extended is 8 inches from the fully retracted position.

Insert load bearing pin (3) through holes in inner and outer tubes and install safety lock pin (2). Tighten setscrew (1) to 88 lb/ft of torque. Tighten jam nut to 85 lb/ft of torque. Never use the setscrew or any other device as a replacement for the load bearing pin (3).

CAUTION

Improper gooseneck height adjustment can result in overloaded tires, blowout and loss of control, leading to serious injury or death.

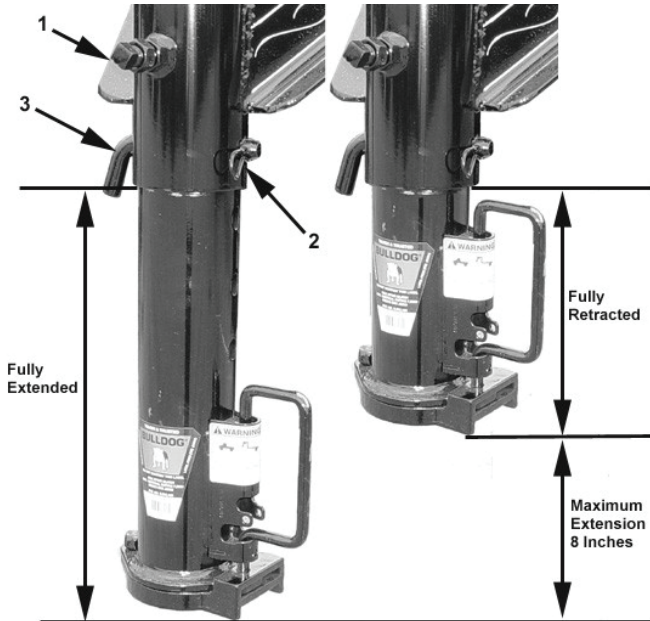

Pre-Tow Checklist

Before towing, double check all of the following:

- ✓ Tires, wheels and lug nuts
- ✓ Tire pressure; inflate tires on trailer a tow vehicle to the pressure stated on the VIN label
- ✓ Coupler secured and locked
- ✓ Safety chains properly fastened to the tow vehicle, not to hitch or ball
- ✓ Test lights
- ✓ Test trailer brakes
- ✓ Safety breakaway switch cable fastened to tow vehicle, not to safety chains
- ✓ Cargo properly loaded, balanced and tied down
- ✓ Tongue weight and weight distribution set-up
- ✓ Ramps secured for travel

Make Regular Stops

After each 50 miles, or one hour of towing, stop and check the following items:

- ✓ Coupler secured
- ✓ Safety chains are fastened and not dragging
- ✓ Cargo secured
- ✓ Ramps secured

Re-Tighten Lug Nuts at First 10, 25 & 50 Miles

Wheel lugs can shift and settle quickly after being first assembled, and must be checked after the first 10, 25 and 50 miles of driving. Failure to perform this check may result in a wheel coming loose from the trailer, causing a crash leading to serious injury or death.

CAUTION

Lug nuts are prone to loosen after being first assembled.
Serious injury or death can result.

Check lug nuts for tightness on a new trailer, and after re-mounting a wheel at 10, 25 and 50 miles.

Adjust Brake Shoes at First 200 Miles

Brake shoes and drums experience a rapid initial wear. The brakes must be adjusted after the first 200 miles of use, and each 3,000 miles thereafter. Some axles are fitted with a mechanism that will automatically adjust the brake shoes. Read your axle and brake manual to see if your brakes adjust automatically. If you do not have the axle and brake manual, contact your dealer for assistance.

Synchronizing the Brake Systems

Trailer brakes are designed to work in synchronization with the brakes on the tow vehicle. When the tow vehicle and trailer braking systems are synchronized, both braking systems contribute to slowing, and the tongue of the trailer will neither dive nor rise sharply.

To insure safe brake performance and synchronization, read and follow the axle/brake and brake controller manufacturers' instructions. If you do not have these instructions, contact your dealer for assistance.

CAUTION

If trailer and tow vehicle brakes do not work properly together, serious injury or death can occur.

Road test the brakes in a safe area at no more than 30 m.p.h before each tow.

Ball Coupler

The ball coupler on the trailer connects to the ball attached to the hitch on the tow vehicle. The ball coupler, ball and hitch transfer the towing forces between the tow vehicle and the trailer. Before each tow, coat the ball with a thin layer of automotive bearing grease to reduce wear and ensure proper operation; and check the locking device that secures the ball coupler to the ball for proper operation.

If you see or feel evidence of wear, such as flat spots, deformations, pitting or corrosion on the ball or ball coupler, immediately have your dealer inspect them to determine the proper action to prevent possible failure of the ball and coupler system. All bent or broken coupler parts must be replaced before towing the trailer.

The ball coupler handle lever must be able to rotate freely and automatically snap into the latched position. Oil the pivot points, sliding surfaces and spring ends. Keep the ball pocket and latch mechanism clean. Dirt or contamination can prevent proper operation of the latching mechanism.

When replacing a ball, the load rating must match or exceed the GVWR of the trailer.

Pintle Hook

The pintle on the trailer connects to the pintle hook attached to the hitch on the tow vehicle. The pintle, pintle hook and hitch transfer the towing forces between the tow vehicle and the trailer. Before each tow, coat the pintle with a thin layer of automotive bearing grease to reduce wear and ensure proper operation; and check the locking device that secures the pintle to the pintle hook for proper operation.

If you see or feel evidence of wear, such as flat spots, deformations, pitting or corrosion on the pintle or pintle hook, immediately have your dealer inspect them to determine the proper action to prevent possible failure of the pintle and pintle hook hitch. All bent or broken pintle or pintle hook parts must be replaced before towing the trailer.

Gooseneck

The gooseneck receiver on the trailer connects to a hitch-mounted ball on the towing vehicle. The receiver, ball and hitch transfer the towing forces between the tow vehicle and the trailer. Before each tow, coat the ball with a thin layer of automotive grease to reduce wear and ensure proper operation; and check the locking device that secures the receiver to the ball for proper operation.

Fifth Wheel Kingpin

Before each tow, inspect the fifth wheel and kingpin for wear and coat the contact surface of the fifth wheel plate with water – resistance Lithium-base grease. If you see evidence of wear on the fifth wheel or kingpin, immediately have your dealer inspect them to determine the proper action to prevent failure of the fifth wheel and kingpin system.

Landing Leg or Jack

If a grease fitting is present, you must use a grease gun to lubricate the jack mechanism. Grease the gears in the top of hand cranked jacks once a year by removing the top of the jack and pumping grease into the gears.

CAUTION

Improper operating tail lights, stop lights and turn signals can cause collisions.

Check all lights before each tow.

Lights and Signals

Before each tow, check the trailer tail lights, stop lights, turn signals and any clearance lights for proper operation.

Tires

Before each tow, be sure the tire pressure is at the value indicated on the sidewall. Tire pressure must be checked while the tire is cold. Do not check the tire pressure immediately after towing the trailer. Allow at least three hours for a tire to cool, if the trailer has been towed for as much as one mile. Replace the tire before towing the trailer if the tire treads have less than 1/16 inch depth or the tell tale bands are visible.

A bubble, cut or bulge in a side wall can result in a tire blowout. Inspect both side walls of each tire for any bubble, cut or bulge and replace a damaged tire before towing the vehicle.

CAUTION

Worn, damaged or under-inflated tires can cause loss of control, resulting in damage, serious injury or death.

Inspect tires before each tow.

Wheels

If the trailer has been struck or impacted, on or near the wheels, or if the trailer has struck a curb, inspect the rims for damage and replace any damaged wheel. Inspect the wheels for damage every year, even if no obvious impact has occurred.

Wheels, Bearings and Lug Nuts

A loose, worn or damaged wheel bearing is the most common cause of brakes that grab. To check your bearings, jack trailer and check wheels for side to side looseness. If the wheels are loose or spin with a wobble, the bearings must be serviced or replaced.

Lug nuts are prone to loosen right after a wheel is mounted to a hub. When driving on a remounted wheel, check to see if the lug nuts are tight after the first 10, 25 or 50 miles of driving and before each tow thereafter.

Tighten the lug nuts to the proper torque for the axle size on your trailer, to prevent wheels from coming loose. Use a torque wrench to tighten the fasteners. Over tightening will result in breaking the studs or permanently deforming the mounting stud holes in the wheels.

CAUTION

Metal creep between the wheel rim and lug nuts will cause the rim to loosen and could result in a wheel coming off, leading to death or serious injury.

Tighten lug nuts before each tow.

Lug Nut Torque - Steel Wheels

Axle Rating (Lbs.)	Stud Size	Torque - Ft. Lbs.
3,500	1/2 inch	90 to 120
6,000 6 Lug	1/2 inch	90 to 120
6,000 & 7,000 8 Lug	9/16 inch	90 to 120
8,000	5/8 in. flanged	275 to 325
10,000	5/8 inch	190 to 210
12,000	5/8 inch	190 to 210
22,500	M22 x 1.5 Swivel Flange	450 to 500

Lug Nut Torque - Aluminum Wheels

Rim Size	Stud Size	Torque - Ft. Lbs.
15" and 16" 5, 6, or 8 Hole	1/2"	65 - 75

Electrical Connections - Construction Trailers

7 Way "RV Type Plug"

7 Way "RV Type Plug": the wires from the trailer junction box are connected to the color markings on the plug.

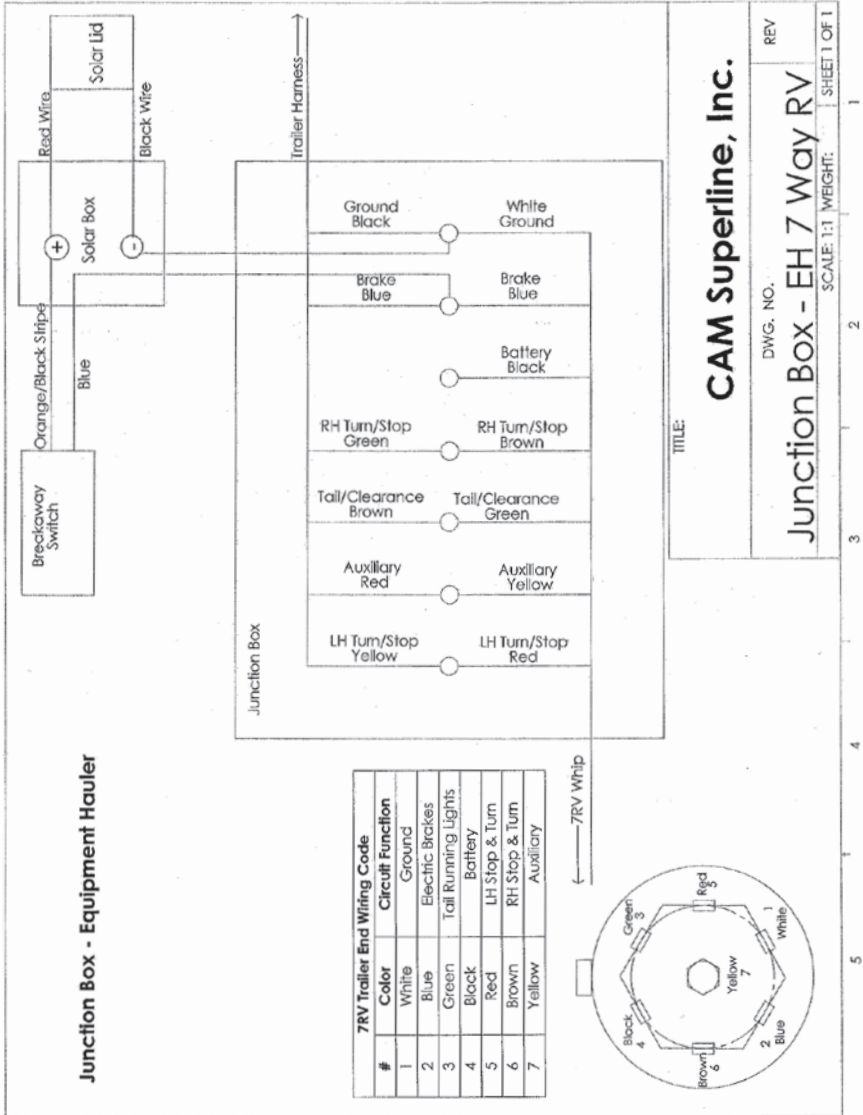

6 Way Round Plug

6 Way Round Plug; the wires from the trailer junction box are connected to the color markings on the plug.

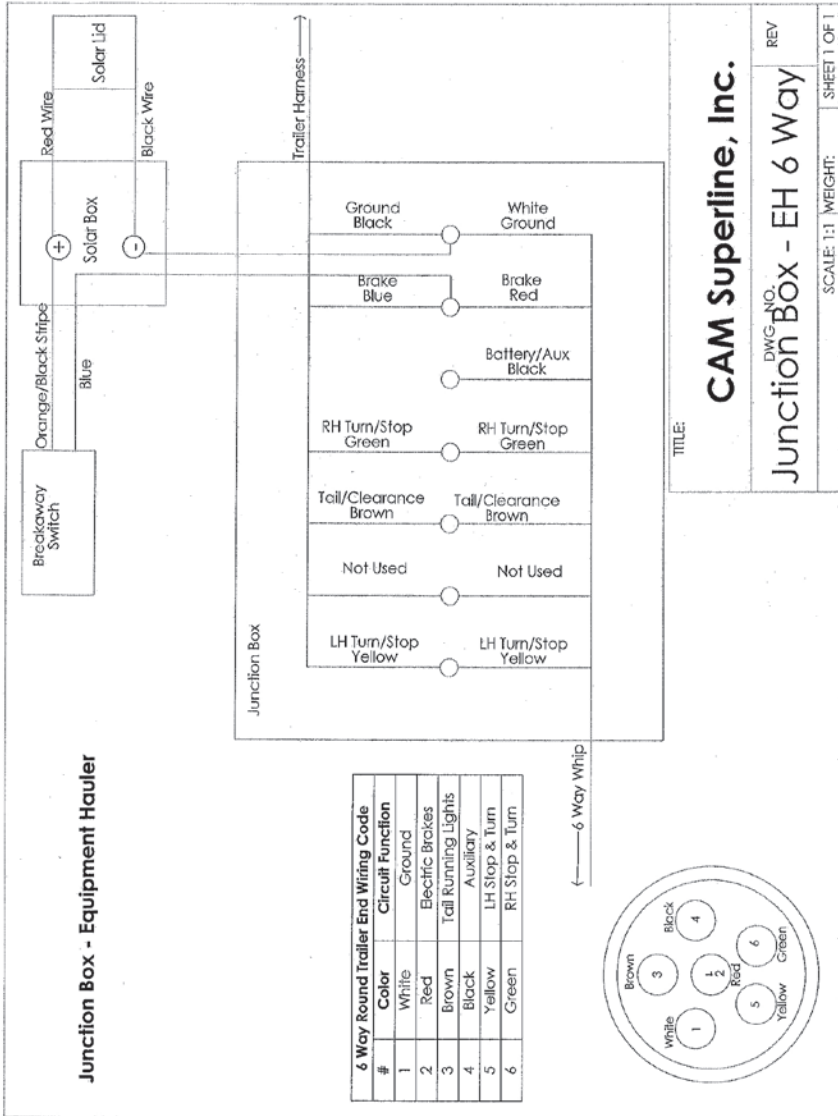

Electrical Connections - Dump Trailers

7 Way RV Type Plug

7 Way "RV Type Plug": the wires from the trailer junction box are connected to the color markings on the plug.

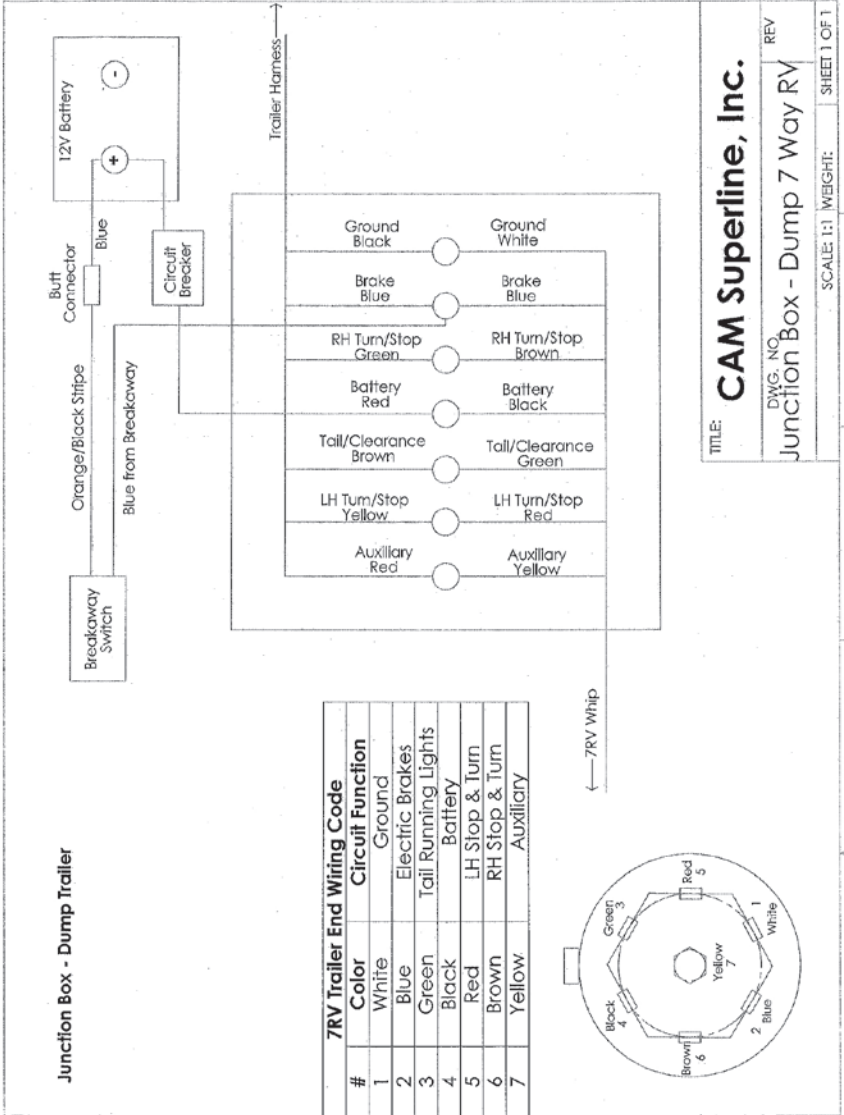

6 Way Round Plug

6 Way Round Plug; the wires from the trailer junction box are connected to the color markings on the plug.

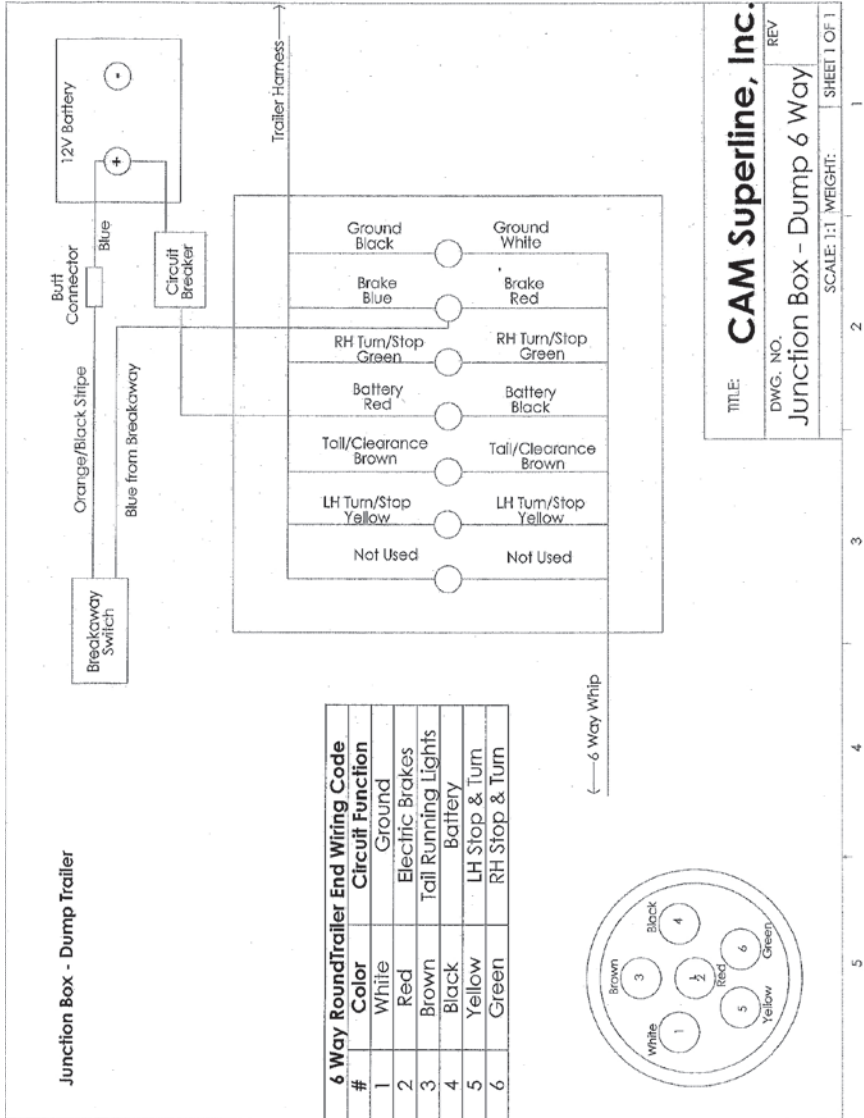

Hydraulic Fluid and Reservoir

Your trailer may be equipped with hydraulic pump and motor.

AW-32 Exxon Mobil is the best, readily available fluid for most climate conditions.

Correct filling and operating procedure: Fill reservoir to within 2-3" from the top, with the cylinder in the fully retracted position. See page 49 for additional information regarding the hydraulic power unit.

CAUTION

Do not use a solid plug or a fill cap without a filter/breather element or damage will occur to the pump and/or reservoir.

Problems Associated with the Reservoir

Clear oil, flowing out of the fill hole:

- Cylinders were not fully retracted when reservoir was filled.
- Reservoir is over filled.

Foamy oil, flowing out of the fill hole:

- Air is present in the cylinders and fluid lines. The response is usually "spongy" and the cylinder moves with a "jerking" motion.

Water in the oil:

- Water can enter the reservoir through the fill hole if the unit is washed and high-pressure washers. Protect the unit whenever possible, and change oil if contamination occurs.

Trouble Shooting the Hydraulic System

Probable causes if the motor fails to start:

- Solenoid or Electric Switch
- "Open" Circuit
- Dead Battery or Corroded Terminals

CAUTION

NEVER alter or substitute any hydraulic system component. An altered or component substituted hydraulic system may malfunction, resulting in the body of the trailer to fall without warning.

Serious injury or death may result.

M-319 (M-719 & M-3519 Are Similar)

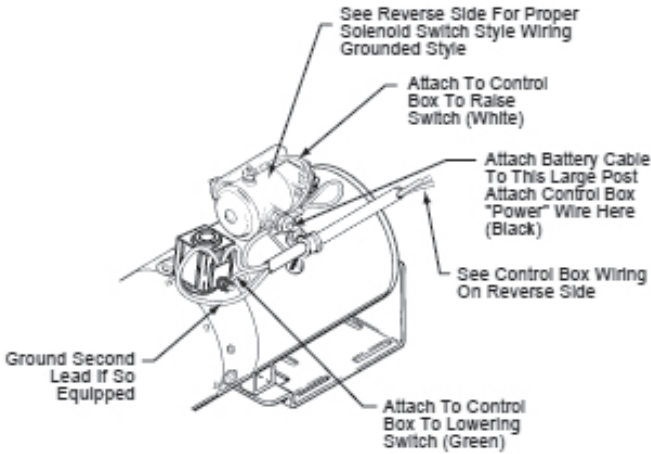

5 J/8

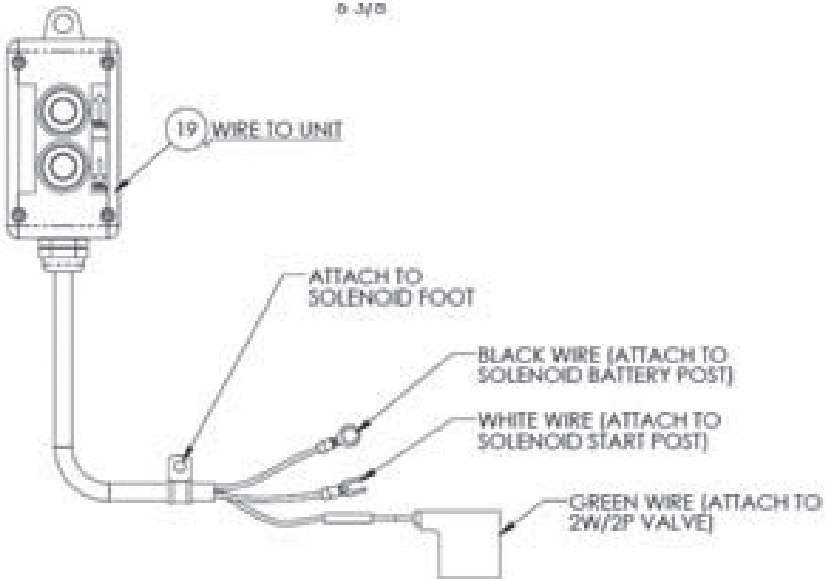

Preparing the Trailer for Loading

Before loading cargo onto the trailer:

- Inspect the deck of the trailer for damage.
- Inspect the stake pockets and/or d-rings. Tie downs must be sturdy with no visible cracks. D-rings must be tight to the deck and must not be bent.

If the deck or any required tie down is damaged, do not load the cargo. Take the trailer to your dealer or competent repair service before using it to carry cargo.

Couple the trailer to the tow vehicle before loading. This is essential for the bumper pull trailer because the tongue of the bumper pull trailer can rise during loading, before the cargo is properly distributed. To measure the tongue weight, you will have to uncouple the trailer after it is loaded.

CAUTION

Damaged or loose tie downs can break, allowing cargo to become loose. Loose cargo can shift the center of gravity, and result in loss of control of the trailer. Inspect tie downs and test them for looseness before loading cargo.

Do not use damaged or loose tie downs to secure the load.

Checking Tongue Weight

To check the tongue weight, the tow vehicle and trailer must be on level ground, as they will be when the trailer is being towed. If you know the weight on your tow vehicle axles when you are not towing a trailer, trailer tongue weight can be determined with the use of a truck axle scale.

Tongue Weight

It is critical to have a portion of the trailer load carried by the tow vehicle. That is, the trailer tongue must exert a downward force on the hitch. This is necessary for two reasons: 1. The proper amount of tongue weight is necessary for the tow vehicle to be able to maintain control of the tow vehicle/trailer system. If, for example, the tongue exerts an upward pull on the hitch, instead of pushing down on it, the rear wheel of the tow vehicle can lose traction or grip and cause loss of control. 2. Even if there is some weight on the tongue, but not enough weight, the trailer can suddenly become unstable at high speeds. If, on the other hand, there is too much tongue weight, the front wheels of the tow vehicle can be too lightly loaded and cause loss of steering control and traction, as well, if the front wheels are driving.

Loading Cargo

In addition to tow vehicle control, tongue weight is necessary to ensure that the trailer axle(s) do not exceed their Gross Axle Weight Rating (GAWR).

In the table below, the second column notes the rule of thumb percentage of

Tongue weight as a percentage of loaded trailer weight

Type of Hitch	Percentage
Bumper Hitch	10-15%
Gooseneck Hitch	20-25%
Fifth Wheel Hitch	20-25%

total weight of the trailer plus its cargo (Gross Vehicle Weight Rating or GVWR) that should appear on the tongue of the trailer. For example, a trailer with a gooseneck hitch, with a loaded weight of 12,000 lbs., should have 20-25% of 12,000 lbs. on the tongue. That is, the example trailer would have 2,400 to 3,000 lbs. on its tongue.

Securing the Cargo

Load the cargo onto the trailer with approximately 60% of the cargo on the front half of the trailer. Secure the cargo to the trailer using appropriate straps, chains and tensioning devices. Refer to www.fmsca.dot.gov for regulations regarding cargo securing rules. Since the trailer ride can be bumpy and rough, you must secure your cargo so that it does not shift while the trailer is being towed.

CAUTION

Shifting cargo can result in loss of control of the trailer and lead to serious injury or death.

Tie down all loads with appropriate sized straps, ropes, chains, and tensioning devices.

Loading the Trailer

Improper trailer loading causes many accident and deaths. To safely load a trailer you must consider:

- Overall load weight
- Load weight distribution
- Proper tongue weight
- Securing the load properly

To determine that you have loaded the trailer within its ratings, you must consider the distribution of weight as well as the total weight of the trailer and its contents. The trailer axles carry most of the total weight of the trailer and its contents (GVWR). The remainder of the total weight is carried by the tow vehicle hitch. It is essential for safe towing that the trailer tongue and a tow vehicle hitch carry the proper amount of the loaded trailer weight, otherwise the trailer can develop an undesirable sway at towing speeds, or the rear of the towing vehicle can be overloaded.

The load distribution must be such that no component part of the trailer is loaded beyond its rating. This means you must consider the rating of the tires, wheels and axles. For tandem and triple axle trailers, you must make sure that the front-to-rear load distribution does not result in overloading any axle.

Towing stability also depends on keeping the center of gravity as low as possible. Load heavy items on the floor and over the axles. When loading additional items, be sure to maintain even side-to-side weight distribution and proper tongue weight.

CAUTION

An overloaded trailer can result in loss of control of the trailer, leading to serious injury or death.

Do not load a trailer so that the weight on any tire exceeds its rating.

Do not exceed the trailer Gross Vehicle Weight Rating (GVWR) or the axle's Gross Axle Weight Rating (GAWR).

Ramp Types

Your flatbed trailer can be equipped with one of several different ramp options:

- Ladder or wood filled ramps
- Landscape ramps
- Removable ramps

CAUTION

Unsecured ramps can create a driving hazard. Secure ramps in their storage or travel position before towing trailer.

Ladder or Wood Filled Ramps & Landscape Ramps

Ramps shown below are in the travel/storage position. Your trailer may have ramps that fold over against the trailer deck for travel. If ramps do not fold over against the trailer deck, the stabilizer bars and safety lock pins on all ramps shown must be installed for travel. To lower ramps, remove safety lock pins, stabilizer bars and lower ramps.

Removable Ramps

Your trailer may be equipped with removable ramps, which may be stored and accessed under the rear of the trailer.



Loading and Unloading a Tilt Trailer

The CAM Superline tilt trailer line; single axle tilt, full deck tilt, split deck tilt, deck over full tilt and deck over split tilt, are equipped with a tilt locking latch that keeps the trailer deck closed or in the travel position. After the trailer is loaded and the cargo is secured with hold downs, be sure the tilt latches are in the locked position prior to moving the trailer.

Hook the trailer to the tow vehicle before attempting to tilt the deck and load cargo on the trailer. Unfold the tilt latch handle, push the thumb latch and pull down the handle to release the tilt locking mechanism(s). A control valve is mounted either on the front, or on the street side of the trailer to allow the trailer to tilt. After the trailer is loaded and the cargo is secured with hold downs, be sure the tilt latches are in the locked position and the control valve is in the “closed” position prior to moving the trailer.



**Fold-able Tilt Latch -
Open Tilting Position**



**Fold-able Tilt Latch -
Closed Travel Position**

CAUTION

A tilt deck can pinch and crush. Keep away from the deck while tilting to avoid injury.

CAUTION

An unlocked tilt deck can result in loss of cargo or loss of control of the trailer, which can result in serious injury or death.

Loading the Trailer

Improper trailer loading causes many accident and deaths. To safely load a trailer you must consider:

- Overall load weight
- Load weight distribution
- Proper tongue weight
- Securing the load properly

To determine that you have loaded the trailer within its ratings, you must consider the distribution of weight as well as the total weight of the trailer and its contents. The trailer axles carry most of the total weight of the trailer and its contents (GVWR). The remainder of the total weight is carried by the tow vehicle hitch. It is essential for safe towing that the trailer tongue and a tow vehicle hitch carry the proper amount of the loaded trailer weight, otherwise the trailer can develop an undesirable sway at towing speeds, or the rear of the towing vehicle can be overloaded.

The load distribution must be such that no component part of the trailer is loaded beyond its rating. This means you must consider the rating of the tires, wheels and axles. For tandem and triple axle trailers, you must make sure that the front-to-rear load distribution does not result in overloading any axle.

Towing stability also depends on keeping the center of gravity as low as possible. Load heavy items on the floor and over the axles. When loading additional items, be sure to maintain even side-to-side weight distribution and proper tongue weight.

Slide-Out Ladder Ramps & Landscape Gate/Ramps

Ramps shown below are in the load/unload position. Landscape gate/ramps include tailgate pins and safety lock pins to secure ramps during travel. To lower ramps, remove tailgate pins and lower ramps. Your trailer may be equipped with removable slide-out ladder ramps, which may be stored and accessed under the rear of the trailer. Slide-out ladder ramps include a safety spring latch to secure ramps during the travel position.



Landscape Gate/Ramp



Slide-Out Ladder Ramps

Hazards for Dump Trailers

A dump trailer is specifically designed for hauling cargo that is to be dumped, and equipment or palletized loads. The major hazards associated with dump trailers are:

- Overloading.
- Improper weight distribution: both side-to-side and front-to-back.
- Getting under a raised dump body.
- Not using, or improperly using the safety prop.
- Modifying or altering the hydraulic components.
- Modifying or altering the dump controls.
- Not dumping from a solid and level foundation.
- Not fully opening rear doors when dumping.
- Jerking the trailer, or hydraulics, to loosen the load.
- Trailer coming near or contacting overhead power lines when body is raised.

CAUTION

An overloaded trailer or improperly distributed load can result in serious injury or death.

An overloaded trailer can cause the hydraulic system to malfunction, resulting in the dump body falling.

An improperly distributed load in the trailer can result in the trailer tipping over when the dump body is raised.

CAUTION

A soft and/or uneven surface may cause the tow vehicle and trailer to tip over when the dump body is raised.

Raise the dump body **ONLY** if the tow vehicle and trailer are both on a firm and level surface.

Loading Fixed Loads

Fixed loads include palletized materials, skid-steer loaders, mowers, etc.

Fixed loads that are to be carried or dumped should be loaded evenly throughout the trailer. Too much load in the front portion will strain and possibly overload the hydraulic cylinder(s). Too much load in the rear can lead to trailer swaying at highway speeds.

- Couple the trailer to the tow vehicle.
- Park the tow vehicle and trailer on a firm and level surface, both front-to-back and side-to-side. Attempting to load on a soft or uneven surface may cause the trailer to overturn, which can result in serious injury or death.
- Inspect the tie down rings for any damage or cracks.
- Clear the area around the trailer.

CAUTION

Loads can suddenly move or topple, which can result in serious injury or death.

Do not load or unload trailer unless coupled to a tow vehicle. Trailer and tow vehicle must be on a firm and level surface.

Rear Loading Equipment

- The tow vehicle must be coupled to the trailer prior to loading equipment.
- This is essential because the tongue can rise during loading.
- Open both rear doors and secure doors in the open position.
- For trailers with ramps under the bed, remove ramps from the travel position and place the ramps at the proper width and load the equipment. The operator must be experienced and skilled to perform the loading and unloading.
- Secure the cargo to the trailer using appropriate straps, chains and tensioning devices. Refer to www.fmsca.dot.gov for regulations regarding cargo securing rules.
- Remove ramps and place in the travel position. Make sure the ramp spring pins have secured the ramps in place.
- Close and secure the rear doors.

Prepare Trailer for Loading

Couple the trailer to the towing vehicle before loading. This is essential because the tongue can rise during loading. To measure the tongue weight you will have to uncouple the trailer after it is loaded. Be sure the trailer is located on firm level ground. Attempting to load on uneven ground may cause the trailer to overturn, which can result in serious injury or death.

Do not transport people, containers of hazardous substances or flammable liquids. The exception is fuel in the tank of vehicles or equipment being hauled.

CAUTION

Raised dump body can drop or tip over suddenly.
You and others can be seriously injured or die.

YOU MUST:

- Have trailer on level, firm ground before dumping.
- Keep others away while dumping.
- Stay at controls until dump is down.

Never leave the trailer when the dump body is lifted.

- Have dump body down before moving trailer.
- Used the safety prop and have the dump body empty before getting under raised dump body.

Never assist the cylinder (i.e., with a jack, crane, heavy equipment etc.)

- If the load does not leave the dump body, lower the dump body and manually free the load.
- Never attempt to free a load from a raised dump body.

Loading and Unloading Bulk Materials

Determine the payload, or cargo capacity, by subtracting the empty weight of the trailer from the GVWR given on the certification/VIN tag. Determine the density of the material to be loaded and dumped so that you will know, approximately, how many cubic yards of material may safely be loaded, carried and dumped.

CAUTION

Trailer, hitch or dump body can fail leading to serious injury or death.

Trailer load must not exceed capacity and must be distributed evenly.

Loading Bulk Material

- Couple the trailer to the tow vehicle.
- Park the trailer and tow vehicle on a firm and level surface, both side-to-side and front-to-rear.
- Check the dump body for damage. Repair before loading trailer.
- Know the GVWR of your trailer and the material being loaded.
- Use common sense when loading. If you are uncertain of the weight of the material, load a small amount and weight your trailer. It is much easier to add to a light load than to remove material from an overloaded trailer.
- Level (evenly distribute) the load within the trailer from front-to-back and from side-to-side.
- If material may blow out while driving, tarp the trailer.
- If the trailer is overloaded, DO NOT attempt to raise the dump body. The excess material must be removed by equipment designed for this purpose, or by hand.

CAUTION

NEVER enter the area under the dump body unless the empty dump body is supported by the safety prop.

A lowering or falling dump body can result in death or serious injury.

CAUTION

The safety prop is designed to support an empty dump body only.
NEVER support a loaded dump body by the safety prop.

Unload Bulk Material Using the Spreader Gate

- Clear the area around the dump trailer.
- Park the tow vehicle and trailer on a firm and level surface both side-to-side and front-to-rear. Attempting to unload on a soft or uneven surface may cause the trailer to overturn, which can result in serious injury or death.
- When spreading material, the surface in which the tow vehicle and trailer will travel **MUST** be firm and level.
- Set the spreader chains at the desired setting to control the opening distance of the spreader gate. Be sure to set both chains at equal lengths. Unlock the spreader gate by removing the bottom pins. For combo split barn door/spreader gates pull the lever upwards to unlock the spreader gate.

CAUTION

Loaded materials can exert pressure against the spreader gate. This may cause the gate to swing out with force when unlocked, causing serious injury.

- Open the pump box. Locate the dump remote controller. While using the dump remote controller, position yourself in a safe location clear of the dump. Check for overhead power lines and other obstructions before raising the dump body.
- Press and hold the up button to raise the dump body. Release the button when the body has reached approximately the halfway point of its dumping angle, or if the load begins to shift rearward. Never leave the dump body control when operating the dump body.

CAUTION

Fully raising the loaded dump body may result in the tow vehicle rear wheels losing traction. Do not fully raise a loaded dump body or place the entire load at the rear of the trailer.

- Return the dump body control to the battery box. Watch for and avoid obstructions such as tree limbs, overhead lines, potholes, etc. and **SLOWLY** drive the tow vehicle and trailer ahead to spread the material.
- **DO NOT** drive forward and stop quickly to “shock” the load out of the body. The proper procedure for a stuck load is to fully lower the dump and dislodge the material by hand.
- You may need to raise the dump body higher after a portion of the load has been spread to place the remaining material at the rear of the dump body.
- Stop the tow vehicle after all the material has exited the dump body.
- Press and hold the down button to lower the dump body. Release the button when the dump body is fully lowered. Place dump body controller in the storage or travel location. Close and lock the battery box.
- Close and latch the rear door before moving the trailer.

Unload Bulk Material Using the Split Barn Door & Combination Spreader/ Split Barn Door Gate

- Clear the area around the dump trailer.
- Park the tow vehicle and trailer on a firm and level surface both side-to-side and front-to-rear. Attempting to unload on a soft or uneven surface may cause the trailer to overturn, which can result in serious injury or death.
- When spreading material, the surface in which the tow vehicle and trailer will travel **MUST** be firm and level.
- Remove the safety lock pin and cam latch to release the split barn doors. Lock the doors against the side of the trailer with the spring latches located on the door.
- Open the battery box and support lid with prop rod. Locate the dump remote controller. While using the dump remote controller, position yourself in a safe location clear of the dump. Check for overhead power lines and other obstructions before raising the dump body.
- Press and hold the up button to raise the dump body. Release the button when the body has reached approximately the halfway point of its dumping angle, or if the load begins to shift rearward. Never leave the dump body control when operating the dump body.
- Discontinue pushing the up button and walk to the rear of the trailer so you can estimate if there is enough space for the remainder of the load to be safely dumped.
- Repeat the process until the load has been completely dumped.
- Return the dump body control to the battery box. Watch for and avoid obstructions such as tree limbs, overhead lines, potholes, etc. and **SLOWLY** drive the tow vehicle and trailer ahead to spread the material.
- **DO NOT** drive forward and stop quickly to “shock” the load out of the body. The proper procedure for a stuck load is to fully lower the dump and dislodge the material by hand.
- You may need to raise the dump body higher after a portion of the load has been spread to place the remaining material at the rear of the dump body.
- Stop the tow vehicle after all the material has exited the dump body.
- Press and hold the down button to lower the dump body. Release the button when the dump body is fully lowered. Place dump body controller in the storage or travel location. Close and lock the battery box.
- Close and latch the rear door before moving the trailer.

Hydraulic Reservoir & Components

Check the fluid level prior to using the trailer. The reservoir is located inside the battery box on the tongue of the trailer. The dump body must be fully lowered before checking fluid levels. The reservoir should be filled to the full mark on the side of the reservoir.

Do not alter or substitute the hydraulic components on the dump trailer. The hydraulic system is designed with each component being compatible with the safe and reliable operation. Under no circumstances should you alter the hydraulic pressure or flow rate in the hydraulic system.

Always have the hydraulic system repaired or maintained by a qualified technician. See page 34-35 for additional information on the hydraulic system.

Recommendations by CAM Superline, Inc. for gravity down cylinder storage and preservation. The gravity down hydraulic cylinder uses hydraulic oil to extend the cylinder and gravity/weight of the trailer to retract the cylinder. All the cylinder components except the seals are made from carbon steel. The gravity down side of the cylinder does not use hydraulic oil to retract, additional owner provided protection is essential during non-use storage. CAM Superline, Inc. recommends lubricating the interior of the cylinder with hydraulic AW32. Interior cylinder can be lubricated by removing breather and top port of cylinder. Silicone lubricant can also be applied to the chrome rod when it is extended. In situations where the cylinder rod will not be cycled, additional corrosion protection is recommended.

CAUTION

NEVER alter or substitute any hydraulic system component.
Serious injury or death may result.

An altered or component substituted hydraulic system
may malfunction, resulting in the dump body falling
without warning.

NEVER alter or substitute any hydraulic system component.

Safety Prop

The safety prop supplied as part of the trailer is to be used only when the dump body is empty. The purpose of the safety prop is a back-up to the hydraulic system and will hold the empty dump body in a raised position while performing maintenance on the hoist, trailer body or the trailer itself. Park the trailer on a firm and level surface. Raise the dump body and place the safety prop in the upright position. Lower the dump body onto the safety prop.

DO NOT use the safety prop to support a loaded dump body.

DO NOT enter the area under a raised dump body without first supporting the empty dump body up with the body prop.

CAUTION

Risk of death by crushing.
Make sure the dump body is empty.
DO NOT manipulate the safety prop
if a person is near the control.
NEVER go under a raised dump body.
Always use the safety prop for maintenance.

Securing the Cargo

Since the trailer cargo is subjected to longitudinal (front/back) and lateral (side/side) forces you must secure all cargo, so that it does not shift while the trailer is being towed. The tarp rail on trailer so equipped, is to be used only to secure a cover for materials or equipment in transport and not to secure any cargo.

CAUTION

Shifting cargo can result in loss of control of the trailer and can lead to serious injury or death.

Tie down all loads with proper sized fasteners, ropes, straps, etc.

Lubrication Points

DO NOT perform maintenance under a raised dump body without first supporting the empty dump body up with the safety prop.

Pump grease into each fitting on the dump body pivot hinges and rear door hinges every month.

Park the trailer on a firm and level surface. Raise the dump body and hold the body safety prop in the upright position. Lower the dump body so the body safety prop engages the socket on the dump body. Pump grease into the fittings on each end of the cylinder(s).

Slide-Out Ramps

The slide-out ramps are located on the underside of the trailer. These parts are exposed to road grime, water and possibly salt spray. Clean and lubricate the moving parts regularly to keep the slide-out ramps from seizing. Clean and lubricate the slide-out mechanism at least once per season, and more frequently if your trailer is operated in dusty or salt-spray environments. Clean the locations where the ramp passes through the frame. Grease the sliding track.

Accessories

This chapter provides some basic information for the safe operation of several accessories. The following accessories are described in this section:

- Accessory Battery
- Battery Charger
- DC Hydraulic Power Unit

Accessory Battery

Your trailer may be outfitted with a 12 volt battery that operates the DC power unit or other accessories. A fully charged battery will insure proper operation.

If you do not plan to be using the trailer for an extended period, remove the cables from the battery terminals.

The accessory battery must be kept in a charged condition during storage. The battery could freeze and break if it becomes discharged.

Battery Charger/Maintainer

Your trailer may be equipped with a battery charger to maintain the charge in the battery. The charger is ideal for maintaining a battery charge. It is recommended to charge large batteries with a higher capacity charger first and use the trailer charger to maintain the battery after it has been charged. Caution should be used when charging batteries. Batteries produce explosive gas during normal operation. Do not smoke, create sparks or open flames near battery compartment. Batteries contain sulfuric acid which can cause severe burns and blindness if exposed to skin or eyes. Always use eye and skin protection when working around batteries.

Make sure that the connections to the battery are tight. Connect charger to a 120 volt outlet using a grounded extension cord designed for outdoor use. Plug into a “GFI” (Ground Fault Interrupted) receptacle to prevent possible shock.

CAUTION

To reduce the risk of explosion, explosive gases or injury while using your battery charger, follow the precautions listed below:

Read all instructions and cautions printed on the battery charger & battery.

Connect the charger with a 3 prong (grounded) outdoor power cord to a “GFI” outlet.

Always charge the battery in a well ventilated area.

To reduce risk of electrical shock, unplug the charger from the outlet before attempting any maintenance or cleaning.

Do not operate the charger if it has a damaged power cord or plug. Have the cord replaced.

DC Hydraulic Power Unit

A DC hydraulic power unit is used on dump trailers and trailers with power tilting options. Most trailers use a single acting “gravity down” cylinder to operate the dump body while an option available on some models include a dual acting power down cylinder. The control is located in the battery box in the front of the trailer.

Use the push-button control to raise and lower the dump body. The hydraulic system is under extreme pressure. Pressure will be in the hydraulic cylinder and line(s) even when the power unit is not operating. Never disconnect a hydraulic line or fitting without first supporting the empty dump body using the body safety prop.

CAUTION

Hydraulic system is under extreme pressure. To reduce the risk of injury, follow the precautions listed below:

- Always wear eye protection and protective clothing when working around hydraulic systems.
- Remove jewelry and objects that might conduct electricity while working on power units.
- Fluid under pressure can pierce the skin and enter the bloodstream causing severe injury or death.
- Dump body must be supported by body safety prop to prevent movement while being inspected, serviced or repaired.

Inspection, Service & Maintenance Summary Charts

You must inspect, maintain and service your trailer regularly to insure safe and reliable operation. If you cannot or are unsure how to perform the items listed here, have your dealer do them. NOTE: In addition to this manual, also check the relevant component manufacturer's manual.

Inspection & Service Before Each Tow	
Item	Inspect / Service
Breakaway Brakes	
Electric	• Check operation
Hydraulic	• Check fluid level and operation
Breakaway Battery	• Fully charged, connections clean
Brakes	
Electric	• Check operation
Surge	• Check operation • Check master cylinder level
Shoes & Drums	• Adjust
Safety Chains & Hooks	• Check for wear and damage
Ball Coupler & Hitch Ball Pintle Hook & Ring	• Check for cracks, pits and flats. Replace w/ ball and coupler having trailer GVW Rating. • Grease • Check locking device and replace when worn.
Gooseneck Ball, Fifth Wheel & Kingpin	• Check for cracks, pits and flats. Replace w/ ball and coupler having trailer GVW Rating. • Grease • Check locking device and replace when worn.
Tires	• Check tire pressure when cold. Inflate as needed. • Check for damage.
Wheels - Lug Nuts & Hubs	• Check for tightness. • Tighten as needed

Inspection & Service Every 6 Months or 6,000 Miles

Item	Inspect / Service
Brakes, Electric	
Magnets	• Check wear and current draw
Controller (in tow vehicle)	• Check power output (amp) and modulation
Tires	<ul style="list-style-type: none"> • Inspect tread and sidewalls. • Replace tire when treads are worn, when sidewall has a bulge or sidewall is worn. • Rotate every 5,000 miles.

Inspection & Service Every Year or 12,000 Miles

Item	Inspect / Service
Brakes, All Types	
Shoes & Drums	<ul style="list-style-type: none"> • Check for scoring and wear. • Replace per manufacturer's specifications
Jack, Drop-leg	Grease gears at top
Structure	• Inspect. Repair or replace damaged, worn or broken parts.
Frame Members	• Inspect welds, repair as needed.
Welds	
Wheels	
Sealed Bearings (Hubs)	• Disassemble/inspect/assemble and repack. Replace promptly if immersed in water
Unsealed Bearings (Hubs)	• Inspect
Rims	

CAUTION

Worn or broken suspension parts can cause loss of control and injury may result

Have trailer professionally inspected annually and after any impact.

Axle Bolts, Frame, Suspension & Structure

To perform many of the inspection and maintenance activities, you must jack up the trailer. When jacking and using jack stands, place them so as to clear wiring, brake lines and suspension parts (springs, torsion bars, etc.). Place jacks and jack stands under the outer frame rail to which the axles are attached.

CAUTION

Crushing Hazard!

Never crawl under your trailer unless it is on firm and level ground and resting on properly placed and secured jack stands. The tow vehicle and trailer could be inadvertently moved while a person is under the trailer. The tow vehicle engine must be off, ignition key removed and parking brakes set before entering the area under the trailer.

Trailer Structure

Wash the trailer as needed with a power washer and a detergent solution.

Fasteners and Frame Members

Inspect all of the fasteners and structural frame members for bending and other damage, cracks or failure. Repair or replace any damaged fastener and repair the frame member. If you have any questions about the condition or method of repair of fasteners or frame members, get the recommendation of, or have the repair done by your dealer. All repair completed for warranty must be approved prior to any repair or modification completed.

CAUTION

Broken or damaged fasteners or welds can cause injury or damage to trailer and contents. Inspect for, and repair all damaged parts at least once a year.

Welds

All welds can crack or fail when subjected to heavy loads or movement of cargo that was not properly tied to prevent movement. Any time that you know or suspect that the trailer has been subjected to heavy loads or movement of cargo, immediately inspect the welds and fasteners for damage. To prevent severe damage to your trailer, inspect all of the welds for cracks or failure at least once a year.

Trailer Brakes - Electric

Brake Shoes & Drums

Properly functioning brake shoes and drums are essential to ensure safety. You must have your dealer inspect these components at least once per year, or every 12,000 miles.

The brake shoes must be adjusted after the first 200 miles of use, and each 3,000 miles thereafter. Most axles are fitted with a brake mechanism that will automatically adjust the brake shoes when the trailer is “hard braked” from a rearward direction. Read your axle and brake manual to see how to adjust your brakes. If you do not have this manual, contact your dealer for assistance.

Manually Adjusting Brake Shoes

Some braking systems are not automatically adjusted by hard stopping. These brakes require manual adjustment. The following steps apply to adjust most manually adjustable brakes. Read your axle and brake manual to see how to adjust your brakes. If you do not have this manual, contact your dealer for assistance.

- Jack up the trailer and secure it on adequate capacity jack stands.
- Be sure the wheel and brake drum rotate freely.
- Remove the adjusting-hole cover and the adjusting slot on the bottom of the brake backing plate.
- With a screwdriver or standard adjusting tool, rotate the starwheel of the adjuster assembly to expand the brake shoes. Adjust the brake shoes out until the pressure of the linings against the drum makes the wheel very difficult to turn. NOTE: Your trailer maybe equipped with drop spindle axles. See axle manual for your axle type. You will need a modified adjusting tool for adjusting the brakes in these axles. With drop spindle axles, a modified adjusting tool with about an 80 degree angle should be used.
- Rotate the starwheel in the opposite direction until the wheel turns freely with a slight drag.
- Replace the adjusting-hole cover.
- Repeat the above procedure on all brakes.
- Lower the trailer to the ground.

Brakes, Electric

Two different types of electric brakes may be present on the trailer: an emergency electric breakaway system, which acts only if the trailer comes loose from the hitch and the breakaway pin is pulled. The other brake is an electric braking system that acts whenever the brakes of the tow vehicle are applied.

CAUTION

If electric breakaway brakes do not operate when trailer is uncoupled from the tow vehicle, serious injury or death can occur.

Check emergency breakaway system BEFORE each tow.

Breakaway Brake

Breakaway Battery - This battery supplies the power to operate the trailer brakes if the trailer uncouples from the tow vehicle. Be sure to check, maintain and replace the battery according to the battery manufacturer's instructions.

Breakaway Switch - This switch causes the breakaway battery to operate the electric brakes if the trailer uncouples from the tow vehicle. The lanyard for the pull pin is connected to the tow vehicle, and the switch is connected to the trailer. To check for proper functioning of the switch, battery and brakes, you must pull the pin from the switch and confirm that the brakes apply to each wheel. You can do this by trying to pull the trailer with the tow vehicle, after pulling the pin. The trailer brakes may not lock, but you will notice that a greater force is needed to pull the trailer.

Tow Vehicle Operated Electric Brakes

The electric brakes that operate in conjunction with the tow vehicle brakes must be "synchronized" so that braking is properly distributed to the tow vehicle brakes and the trailer brakes. For proper operation and synchronization, read and follow the axle/brake and the brake controller manufacturer's instructions. If you do not have these instructions, contact your dealer for assistance.

Magnets for all Electric Brakes

To make certain an electrically-operated braking system will function properly, you must have your dealer inspect the magnets at least once a year, or every 12,000 miles. See the brake manual for wear and current inspection instructions.

Trailer Brakes - Surge

Surge Brake Master Cylinder

Check fluid level prior to using the trailer. The master cylinder is located on the tongue of the trailer. The fluid level must be maintained at no less than half full, and no more than 1/2 inch from the top. Use type 3 or 4 automotive brake fluid.

Hydraulic Surge Brakes

Before each tow, perform the following steps:

- Check the brake master cylinder level as instructed above. Check for leaks and repair as required.
- Examine the actuator for wear, bent parts, corroded/seized parts or other damage. Have the affected components replaced with genuine service parts.
- Test the actuator and brake function. Actuator travel over one inch indicates that the brakes need adjustment (or that the actuator has been structurally damaged). Actuator travel is the distance the coupler case assembly moves to the outer case during braking. Adjust the brakes following the instructions given in the brake installation manual. Failure to adjust brakes will result in loss of braking.
- Before storage or after extended use, apply motor oil to the coupler components and the internal rollers to keep them moving freely and prevent corrosion.

See the surge brake manufacturer's manual for other inspection and maintenance activities. If you do not have this manual, contact your dealer for assistance.

Master Cylinder Bleeding

Remove the master cylinder's cap and fill the reservoir to three quarters full with DOT-3 or DOT-4 brake fluid. DO NOT allow brake fluid to contact painted surface since it will damage the finish. Wipe up any spills immediately and wash the area with water.

Bleed the brake system either manually or with a pressure bleeder. Pressure bleeding equipment simplifies the process, and is available at most automotive supply stores. Use the instructions provided with the pressure bleeder. If you chose to manually bleed the system, an assistant is required. Use the following steps to manually bleed the brake system:

- Disconnect the trailer from the tow vehicle and jack the trailer's tongue until it is horizontal. Make sure that the wheels are blocked so that the trailer will not roll away.
- Fill the master cylinder with fluid as described above.
- Install a bleeder hose on the bleeder screw of the farthest wheel cylinder from the actuator. If the trailer has multiple axles, bleed the rear axle first. Submerge the other end of the hose in a glass container of brake fluid, so that air bubbles can be observed.
- Open the bleeder screw and have your assistant stroke (but not release) the actuator. Brake fluid and/or air bubbles will flow into the jar. Close the bleeder screw. The helper can then allow the actuator to return to its rest position.

Repeat the process until no more bubbles are released with the stroke. Air trapped in the brake lines will greatly reduce your braking efficiency. Be sure to close the bleeder screw securely when the cylinder fully bled. Repeat the bleeding operation at each wheel cylinder. During the bleeding process, replenish the master cylinder reservoir with fresh brake fluid so that the level does not fall below half full. This will ensure that no air is drawn into the system.

After all brakes have been bled, refill the master cylinder before operating. Be sure to install the master cylinder filler cap.

CAUTION

Use only fresh brake fluid from a sealed container. DO NOT reuse fluid. After filling and bleeding, refill the actuator. Failure to maintain an adequate fluid level may cause brake failure.

Trailer Connection to Tow Vehicle

Bumper Pull Coupler & Ball

The coupler on the trailer connects to the ball attached to the hitch on the tow vehicle. The coupler, ball and hitch transfer the towing forces between the tow vehicle and the trailer. Before each tow, coat the ball with a thin layer of automotive bearing grease to reduce wear and ensure proper operation; and check the locking device that secures the coupler to the ball for proper operation.

If you see or feel evidence of wear, such as flat spots, deformations, pitting or corrosion, on the ball or coupler, immediately have your dealer inspect them to determine the proper action to prevent possible failure of the ball and coupler system. All bent or broken coupler parts must be replaced before towing the trailer.

The coupler handle lever must be able to rotate freely and automatically snap into the latched position. Oil the pivot point, sliding surfaces and spring ends with SAE 30W motor oil. Keep the ball pocket and latch mechanism clean. Dirt or contamination can prevent proper operation of the latching mechanism.

When replacing a ball, the load rating must match or exceed the GVWR of the trailer.

Pintle Ring & Hook

The ring on the trailer connects to the pintle hook attached to the hitch on the tow vehicle. The ring, pintle and hitch transfer the towing forces between the tow vehicle and the trailer. Before each tow, coat the ring with a thin layer of automotive bearing grease to reduce wear and ensure proper operation; and check the locking device that secures the pintle hook to the ring for proper operation.

If you see or feel evidence of wear, such as flat spots, deformations, pitting or corrosion, on the pintle ring or hook, immediately have your dealer inspect them to determine the proper action to prevent possible failure of the ring and pintle system. All bent or broken parts must be replaced before towing the trailer.

The pintle hook handle lever must be able to rotate freely and automatically snap into the latched position. Oil the pivot point, sliding surfaces and spring ends with SAE 30W motor oil. Keep the pintle ring and latch mechanism clean. Dirt or contamination can prevent proper operation of the latching mechanism. When replacing the pintle ring, the load rating must match or exceed the GVWR of the trailer.

Gooseneck Ball Receiver

The gooseneck receiver on the trailer connects to a hitch-mounted ball on the towing vehicle. The receiver, ball and hitch transfer the towing forces between the tow vehicle and the trailer. Before each tow, coat the ball with a thin layer of automotive bearing grease to reduce wear and ensure proper operation; and check the locking device that secures the receiver to the ball for proper operation.

If you see or can feel evidence of wear, such as flat spots, pitting or corrosion, on the ball or receiver, immediately have your dealer inspect them.

When replacing a ball, the load rating must match or exceed the GVWR of the trailer.

Landing Gear

If a grease fitting is present, you must use a grease gun to lubricate the jack mechanism. Grease the gears in the top of hand-cranked jacks once a year, by removing the top of the jack and pumping or hand packing grease into the gears.

Lights & Signals

Before each tow, check the trailer tail-lights, stop-lights, turn signals and any clearance lights for proper operation.

CAUTION

To avoid risk of collisions, all lights must work.

Wheel

If the trailer has been struck, or impacted, on or near the wheels, or if the trailer has struck a curb, inspect the for damage (i.e. being out of round); and replace any damaged wheel. Inspect the wheels for damage every year, even if no obvious impact has occurred.

Tire Wear Diagnostic Chart

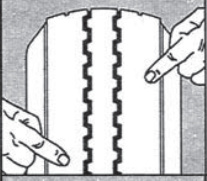
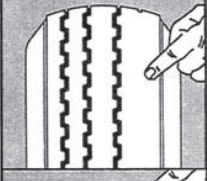
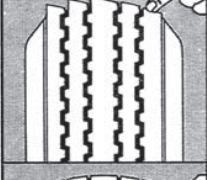
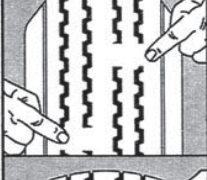
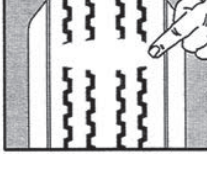
	Condition	Possible Cause	Remedy
	Even Center Wear	Over Inflation	Check & Adjust Pressure When Cold
	Inside & Outside Wear	Under Inflation	Check & Adjust Pressure When Cold
	Smooth, Side Wear - One Side	Loss of Camber or Overloading	Check & Unload As Necessary Have Alignment Checked
	"Feathering" Across The Face	Axle Not Square To Frame or Incorrect Toe In	Square Axles Have Alignment Checked
	Cupping	Loose Bearings or Wheel Balance	Check Bearing Adjustment and Wheel & Tire Balance
	Flat Spots	Wheel Lockup	Adjust Brakes

Tires

Trailer tires may be worn out even though they still have plenty of tread left. This is because trailer tires have to carry a lot of weight all of the time, even when not in use. It is actually better for the tire to be rolling down the road than to be idle. During use, the tire releases lubricants that are beneficial to tire life. Using the trailer often also helps prevent flat spots from developing. The main cause for tire failure is improper inflation.

Before each tow, check the tire pressure to make sure it is at the level indicated on the tire sidewall or VIN label. Tire pressure must be checked while the tire is cold. Do not check tire pressure immediately after towing the trailer. Allow at least three hours for the tires to cool, if the trailer has been towed for as much as one mile.

Tires can lose air over a period of time. In fact, tires can lose 1-3 psi per month. This is because molecules of air, under pressure, weave their way from the inside of the tire, through the rubber to the outside. A drop in tire pressure could cause excessive heat build up. If the tire is under-inflated, even for a short period of time, the tire could suffer internal damage.

High towing speed in hot conditions degrades the tire significantly. As heat builds up during driving, the tire's internal structure starts to breakdown, compromising the strength of the tire. It is recommended to drive at moderate speeds.

Replace the tire before towing the trailer if the treads have less than $\frac{2}{32}$ inch depth or the tell-tale bands are visible.

A bubble, cut or bulge in a side wall can result in a tire blowout. Inspect both side walls of each tire for any bubble, cut or bulge; and replace a damaged tire before towing the trailer.

Statistics indicate the average life of a tire is five years under normal use and maintenance conditions. After three years, replacing the trailer tires with new ones should be considered, even if the tires have adequate tread depth. After five years, trailer tires are considered worn out and should be replaced, even if they have minimal or no use.

If you are storing your trailer for an extended period, make sure the tires are inflated to the maximum rated pressure indicated on the sidewall or VIN label and that you store them in a cool dry place such as a garage. Use tire covers to protect the tires from the harsh effects of the sun.

CAUTION

Never crawl under your trailer unless it is on firm and level ground and resting on properly placed and secured jack stands.

Wheel Bearings

A loose, worn or damaged wheel bearing is the most common cause of brakes that grab. To check your bearings, jack up trailer and check wheels for side-to-side looseness. If the wheels are loose, or spin with a wobble, the bearings must be serviced or replaced.

If your axle(s) are equipped with Dexter E-Z Lube feature, the bearings can be periodically lubricated without removing the hubs from the axle(s). This feature consists of axle spindles that have been specially drilled and fitted with a grease zerk on their ends. When grease is pumped into the zerk, it is channelled to the inner bearing and then flows back to the outer bearing and eventually back out of the grease cap hole.

- Remove the rubber plug from the axle end.
- Place grease gun on zerk

- Pump grease until new grease begins to appear.
- Install rubber plug and cap. Repeat for remaining wheel bearings.

If your trailer axle(s) are not equipped with grease zerks, refer to the axle manufacturer's manual for service and maintenance information.

NOTE: If the hubs are removed from an axle with E-Z Lube feature, it is imperative that the seals are replaced before bearing lubrication. Otherwise, the chance of grease getting on the brake

Oil Bath Axles

If your axles are equipped with oil lubricated hubs, periodically check and refill the hub as necessary with a high quality hypoid gear oil to the level indicated on the clear plastic oil cap. The oil can be filled from either the oil fill hole, if present, in the hub or through the rubber plug hole in the cap itself.

Lug Nuts

Lug nuts are prone to loosen right after a wheel is mounted to a hub. When driving on a remounted wheel, check to see if the lug nuts are tight after the first 10, 25 and 50 miles of driving, and before each tow thereafter.

Tighten the lug nuts in three stages to the final torque for the axle size on your trailer, to prevent wheels from coming loose. Tighten each lug nut in the order shown below. Use a calibrated torque wrench to tighten the fasteners. Verify that wheel studs are free of contaminants such as paint or grease, which may result in inaccurate torque readings. Over-tightening will result in breaking the studs or permanently deforming the mounting stud holes in the wheels.

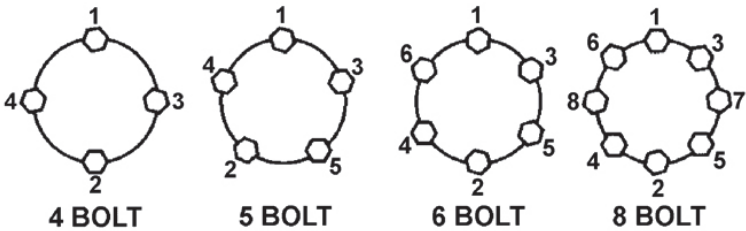

Lug Nut Torque - Steel Wheels		
Axle Rating (Lbs.)	Stud Size	Torque - Ft. Lbs.
3,500	1/2 inch	90 to 120
6,000 6 Lug	1/2 inch	90 to 120
6,000 & 7,000 8 Lug	9/16 inch	90 to 120
8,000	5/8 in. flanged	275 to 325
10,000	5/8 inch	190 to 210
12,000	5/8 inch	190 to 210
22,500	M22 x 1.5 Swivel Flange	450 to 500

Lug Nut Torque - Aluminum Wheels		
Rim Size	Stud Size	Torque - Ft. Lbs.
15" and 16"	1/2"	65 - 75
5, 6, or 8 Hole		

Storage Preparation

If your trailer is to be stored for an extended period of time or over the winter, it is important that the trailer be prepared properly.

- Remove the emergency breakaway battery and store inside out of the weather. Charge the battery at least every 90 days.
- Jack up the trailer and place jack stands under the trailer frame so that the weight will be off the tires. Follow trailer manufacturer's guidelines to lift and support the unit. Never jack up or place jack stand on the axle tube or on the equalizers.
- Lubricate mechanical moving parts such as the hitch, and suspension parts, that are exposed to the weather.
- On oil lubricated hubs, the upper part of the roller bearings are not immersed in oil and are subject to potential corrosion. For maximum bearing life, it is recommended that you revolve your wheels periodically (every 2-3 weeks) during periods of prolonged storage.

After Prolonged Storage - Inspection Procedure

Before removing trailer from jack stands:

- Remove all wheels and hubs or brake drums. Note which spindle and brake that the drum was removed from so that it can be reinstalled in the same location.
- Inspect suspension for wear.
- Check tightness of hanger bolt, shackle bolt and U-bolt nuts per recommended torque values.
- Check brake linings, brake drums and armature faces for excessive wear or scoring.
- Check brake magnets with an ohmmeter. The magnets should check 3.2 ohms. If shorted or worn excessively, they must be replaced.
- Lubricate all brake moving parts using a high temperature brake lubricant.

CAUTION

Do not get grease or oil on brake linings or magnet face.

- Remove any rust from braking surface and armature surface of drums with fine emery paper or crocus cloth. Protect bearing from contamination while so doing.
- Inspect oil or grease seals for wear or nicks. Replace if necessary.
- Lubricate hub bearings.
- Reinstall hubs and adjust bearings.
- Mount and tighten wheels.

Trip Preparation Checklist

There are a number of simple rules to follow in caring for your trailer axle assembly that can add to its life and in the case of some of these rules, you may be protecting your own life as well.

Using the following checklist before starting a trip with your trailer is highly recommended. Some of these items should be checked 2-3 weeks prior to a planned trip to allow sufficient time to perform maintenance.

- ✓ Check your maintenance schedule and be sure you are up-to-date.
- ✓ Check hitch. Is it showing wear? Is it properly lubricated?
- ✓ Fasten safety chains and breakaway switch actuating chain securely. Make certain the breakaway battery is fully charged.
- ✓ Inspect towing hookup for secure attachment.
- ✓ Load your trailer so that approximately 10% of the trailer's total weight is on the hitch. For light trailers this should be increased to 15%.
- ✓ **Do Not Overload.** Stay within your gross vehicle rated capacity (consult your trailer's VIN tag).
- ✓ Inflate tires according to manufacturer's specifications; inspect tires for cuts, excessive wear, etc.
- ✓ Check wheel mounting nuts/bolts with a torque wrench. Torque in proper sequence, to the levels specified in this manual.
- ✓ Make certain the brakes are synchronized and functioning properly.
- ✓ Check tightness of hanger bolt, shackle bolt, and U-bolt nuts per torque values specified in manual.
- ✓ Check operation of all lights.
- ✓ Check that your trailer is towing in a level position and adjust hitch height if required.

Maintenance Schedule					
Item	Function Required	Weekly	3 Months or 3,000 Miles	6 Months or 6,000 Miles	12 Months or 12,000 Miles
Brakes	Test that they are operational	At Every Use			
Brake Adjustment	Adjust to proper operating clearance.		●		
Brake Magnets	Inspect for wear and current draw.			●	
Brake Linings	Inspect for wear or contamination.				●
Brake Controller	Check for correct amperage and modulation.			●	
Brake Cylinders	Check for leaks, sticking.				●
Brake Lines	Inspect for cracks, leaks, kinks.				●
Trailer Brake Wiring	Inspect wiring for bare spots, fray, etc.				●
Breakaway System	Check battery charge and switch operation.	At Every Use			
Hub/Drum	Inspect for abnormal wear or scoring.				●
Wheel Bearings	Inspect for corrosion or wear. Clean and repack.				●
Seals	Inspect for leakage. Replace if removed.				●
Springs	Inspect for bending, loose fasteners and wear.				●
Suspension Parts	Inspect for bending, loose fasteners and wear.			●	
Hangers	Inspect welds.				●
Wheel Nuts and Bolts	Tighten to specified torque values.		●		
Wheels	Inspect for cracks, dents or distortion.			●	
Tire Inflation Pressure	Inflate tires to mfg's specifications.	●			
Tire Condition	Inspect for cuts, wear, bulging, etc.		●		

Limited Warranty

Duration of Warranty

CAM Superline, Inc. offers a two year complete warranty on CAM Superline Trailers and a complete one year warranty on CAM Advantage Series trailers. This warranty covers all defects in material and workmanship under normal wear and rated load capacity.

The warranty is effective beginning with the date of purchase and is applicable to only the original owner of the trailer.

The obligation of this warranty shall be limited to repairing or replacing any part or parts that, in the opinion of CAM Superline, shall be proven defective materials or workmanship under normal use and service. This warranty does not cover any part or parts which have been damaged as a result of an accident, misuse, abuse or which have been modified, repaired or altered without the express written consent of CAM Superline, Inc.

Tires, axles, brake systems, lights, hitches, jacks, cylinders, power units and all related components are warranted by respective manufacturers.

Limitations and Exclusions

This warranty shall not extend to:

- Any trailer for which the warranty registration card was not returned to CAM Superline, Inc.
- Any CAM Superline trailer that has been modified, repaired or altered in anyway without the express written consent of CAM Superline, Inc.
- Unreasonable use (including failure to provide reasonable and necessary maintenance).
- Parts not supplied by CAM Superline, Inc.
- Certain replacement parts that require replacement due to normal wear.

Procedures

To secure repair of the trailer or any warranted parts under this warranty the unit or warranted part must be delivered (charges prepaid) to the nearest CAM Superline dealer or as directed by the company.

Your CAM Superline trailer dealer, from whom you purchased your unit, is responsible for the registration of your warranty with CAM Superline, Inc. So that we may better serve you, we ask that you cooperate with the dealer in supplying the necessary information on the warranty form.

The purchaser acknowledges that he/she has read and understands the owner's manual and the limited warranty and agrees that should any warranty claims be made by the purchaser.



4763 Zane A. Miller Drive
Waynesboro, PA 17268
Phone # 1-800-378-7623
Fax # 1-800-279-7578

Reporting Safety Defects

If you believe that your vehicle has a defect which could cause a crash or could cause injury or death, you should immediately inform the National Highway Traffic Safety Administration (NHTSA) in addition to notifying CAM Superline, Inc.

If NHTSA receives similar complaints, it may open an investigation, and if it finds that a safety defect exists in a group of trailers, it may order a recall and remedy campaign. However, NHTSA cannot become involved in individual problems between you, your dealer or CAM Superline, Inc.

To contact NHTSA, you may either call the Auto Safety Hotline toll-free at:

1-800-424-9393

(or 366-0123 in Washington, DC area)

or write to:

Administrator

National Highway Traffic Safety Administration

1200 New Jersey SE

Washington, DC 20590

You can also obtain other information about motor vehicle safety from the hotline listed above.



4763 Zane A. Miller Drive
Waynesboro, PA 17268

Toll-Free

800.378.7623

Website

www.camsuperline.com