

BUSH HOG®

Models LLR / MLR Landscape Rakes Operator's Manual



OPERATION ● MAINTENANCE

CONGRATULATIONS!

You have invested in the best implement of its type on the market today.

The care you give your Bush Hog implement will greatly determine your satisfaction with its performance and its service life. We urge a careful study of this manual to provide you with a thorough understanding of your new implement before operating, as well as suggestions for operation and maintenance.

If your manual should become lost or destroyed, Bush Hog will be glad to provide you with a new copy. Order from Bush Hog, P. O. Box 1039, Selma, Alabama 36702-1039.

As an authorized Bush Hog dealer, we stock genuine Bush Hog parts which are manufactured with the same precision and skill as our original equipment. Our trained service personnel are well informed on methods required to service Bush Hog equipment, and are ready and able to help you.

Should you require additional information or assistance, please contact us.

YOUR AUTHORIZED
BUSH HOG DEALER

BECAUSE BUSH HOG MAINTAINS AN ONGOING PROGRAM OF PRODUCT IMPROVEMENT, WE RESERVE THE RIGHT TO MAKE IMPROVEMENTS IN DESIGN OR CHANGES IN SPECIFICATIONS WITHOUT INCURRING ANY OBLIGATION TO INSTALL THEM ON UNITS PREVIOUSLY SOLD.

BECAUSE OF THE POSSIBILITY THAT SOME PHOTOGRAPHS IN THIS MANUAL WERE TAKEN OF PROTOTYPE MODELS, PRODUCTION MODELS MAY VARY IN SOME DETAIL. IN ADDITION, SOME PHOTOGRAPHS MAY SHOW SHIELDS REMOVED FOR PURPOSES OF CLARITY. **NEVER OPERATE** THIS IMPLEMENT WITHOUT ALL SHIELDS IN PLACE.

BUSH HOG[®]

LANDSCAPE RAKE

OPERATOR'S MANUAL

TABLE OF CONTENTS

SECTION	PAGE	SECTION	PAGE
Warranty -----	2	Detaching From Tractor -----	6
Dealer Preparation Check List ---	3	Field Adjustments -----	7
Safety Precautions -----	4	II ASSEMBLY-----	7
Laws and Regulations-----	5	III MAINTENANCE -----	7
Specifications -----	6	Safety Decals -----	8
I OPERATION-----	6	Torque Specifications -----	9
Attachment -----	6		

RETAIL CUSTOMER'S RESPONSIBILITY UNDER THE BUSH HOG WARRANTY

It is the Retail Customer and/or Operator's responsibility to read the Operator's Manual, to operate, lubricate, maintain and store the product in accordance with all instructions and safety procedures. Failure of the operator to read the Operator's Manual is a misuse of this equipment.

It is the Retail Customer and/or Operator's responsibility to inspect the product and to have any part(s) repaired or replaced when continued operation would cause damage or excessive wear to other parts or cause a safety hazard.

It is the Retail Customer's responsibility to deliver the product to the authorized Bush Hog Dealer, from whom he purchased it, for service or replacement of defective parts which are covered by warranty. Repairs to be submitted for warranty consideration must be made within forty-five (45) days of failure.

It is the Retail Customer's responsibility for any cost incurred by the Dealer for traveling to or hauling of the product for the purpose of performing a warranty obligation or inspection.



LIMITED WARRANTY



Bush Hog warrants to the original purchaser of any new Bush Hog equipment, purchased from an authorized Bush Hog dealer, that the equipment be free from defects in material and workmanship for a period of one (1) year for non-commercial, state, and municipalities' use and ninety (90) days for commercial use from date of retail sale. The obligation of Bush Hog to the purchaser under this warranty is limited to the repair or replacement of defective parts.

Replacement or repair parts installed in the equipment covered by this limited warranty are warranted for ninety (90) days from the date of purchase of such part or to the expiration of the applicable new equipment warranty period, whichever occurs later. Warranted parts shall be provided at no cost to the user at an authorized Bush Hog dealer during regular working hours. Bush Hog reserves the right to inspect any equipment or parts which are claimed to have been defective in material or workmanship.

DISCLAIMER OF IMPLIED WARRANTIES & CONSEQUENTIAL DAMAGES

Bush Hog's obligation under this limited warranty, to the extent allowed by law, is in lieu of all warranties, implied or expressed, **INCLUDING IMPLIED WARRANTIES OF MERCHANTABILITY AND FITNESS FOR A PARTICULAR PURPOSE** and any liability for incidental and consequential damages with respect to the sale or use of the items warranted. Such incidental and consequential damages shall include but not be limited to: transportation charges other than normal freight charges; cost of installation other than cost approved by Bush Hog; duty; taxes; charges for normal service or adjustment; loss of crops or any other loss of income; rental of substitute equipment, expenses due to loss, damage, detention or delay in the delivery of equipment or parts resulting from acts beyond the control of Bush Hog.

THIS LIMITED WARRANTY SHALL NOT APPLY:

1. To vendor items which carry their own warranties, such as engines, tires, and tubes.
2. If the unit has been subjected to misapplication, abuse, misuse, negligence, fire or other accident.
3. If parts not made or supplied by Bush Hog have been used in connection with the unit, if, in the sole judgement of Bush Hog such use affects its performance, stability or reliability.
4. If the unit has been altered or repaired outside of an authorized Bush Hog dealership in a manner which, in the sole judgement of Bush Hog, affects its performance, stability or reliability.
5. To normal maintenance service and normal replacement items such as gearbox lubricant, hydraulic fluid, worn blades, or to normal deterioration of such things as belts and exterior finish due to use or exposure.
6. To expendable or wear items such as teeth, chains, sprockets, belts, springs and any other items that in the company's sole judgement is a wear item.

NO EMPLOYEE OR REPRESENTATIVE OF BUSH HOG IS AUTHORIZED TO CHANGE THIS LIMITED WARRANTY IN ANY WAY OR GRANT ANY OTHER WARRANTY UNLESS SUCH CHANGE IS MADE IN WRITING AND SIGNED BY BUSH HOG'S SERVICE MANAGER, POST OFFICE BOX 1039, SELMA, ALABAMA 36702-1039.



Record the model number, serial number and date purchased. This information will be helpful to your dealer if parts or service are required.

MODEL NUMBER _____

SERIAL NUMBER _____

MAKE CERTAIN THE WARRANTY REGISTRATION CARD HAS BEEN FILED WITH BUSH HOG/ SELMA, ALABAMA

DATE OF RETAIL SALE _____

DEALER PREPARATION CHECK LIST

LANDSCAPE RAKE

BEFORE DELIVERING MACHINE — The following check list should be completed.
Use the Operator's Manual as a guide.

- 1. Assembly completed.
- 2. All fasteners torqued to specifications given in Torque Chart.
- 3. All decals in place and readable. (See decal page.)
- 4. Overall condition good (i.e. paint, welds)
- 5. Operators manual has been delivered to owner and he has been instructed on the safe and proper use of the rake.
- 6. Optional Gauge Wheel - Properly installed and lubricated.

Dealer's Signature _____

THIS CHECKLIST TO REMAIN IN OWNER'S MANUAL

It is the responsibility of the dealer to complete the procedures listed above before delivery of this implement to the customer.

IMPORTANT SAFETY PRECAUTIONS

This symbol is used to call attention to safety precautions that should be followed by the operator to avoid accidents. When you see this symbol, carefully read the message that follows and heed its advice. Failure to comply with safety precautions could result in serious bodily injury.



In addition to the design and configuration of equipment, hazard control and accident prevention are dependent upon the awareness, concern, prudence and proper training of personnel in the operation, transport, maintenance and storage of equipment. Lack of attention to safety can result in accident, personal injury, reduction of efficiency and worst of all—loss of life. Watch for safety hazards and correct deficiencies promptly. Use the following safety precautions as a general guide to safe operations when using this machine. Additional safety precautions are used throughout this manual for specific operating and maintenance procedures. Read this manual and review the safety precautions often until you know the limitations.

1. Read the Operator's Manual. Failure to read the Operator's Manual is considered a misuse of this equipment.
2. Become familiar with all the machine's controls and all the caution, warning and danger decals affixed to the machine before attempting to start or operate.
3. Before starting or operating the machine, make a walk around inspection and check for obvious defects such as loose mounting bolts and damaged components. Correct any deficiency before starting.
4. Do not allow children to operate the implement. Do not allow adults to operate it without proper instruction.
5. Do not carry passengers.
6. Keep the area of operation clear of all persons, particularly small children and pets. The operator should cease raking whenever anyone comes within the operating area.
7. Lower implement to ground, stop tractor engine, and apply parking brake before leaving the tractor.
8. Keep hands and feet away from implement.
9. Wear personal protective equipment such as, but not limited to, protection for eyes, ears, feet, hands and head when operating or repairing the equipment. Do not wear loose clothing or jewelry that may catch on equipment parts.
10. When performing adjustments or maintenance on the implement, first lower it to the ground or block it securely at a workable height.
11. Never stand between tractor and implement while tractor is being backed to the hitch.
12. Reduce speed when transporting implement to avoid bouncing and momentary loss of steering.
13. Use tractor flashing warning lights, day or night, when transporting implement on road or highways unless prohibited by law.
14. It is recommended that tractor be equipped with Rollover Protective System (ROPS) and seat belt be used in all implement operations.

IMPORTANT FEDERAL LAWS AND REGULATIONS* CONCERNING EMPLOYERS, EMPLOYEES AND OPERATIONS.

*(This section is intended to explain in broad terms the concept and effect of the following federal laws and regulations. It is not intended as a legal interpretation of the laws and should not be considered as such).

U.S. Public Law 91-596 (The Williams-Steiger Occupational and Health Act of 1970) OSHA

This Act Seeks:

“...to assure so far as possible every working man and woman in the nation safe and healthful working conditions and to preserve our human resources...”

DUTIES

Sec. 5 (a) Each employer—

- (1) shall furnish to each of his employees employment and a place of employment which are free from recognized hazards that are causing or are likely to cause death or serious physical harm to his employees;
- (2) shall comply with occupational safety and health standards promulgated under this Act.
 - (b) Each employee shall comply with occupational safety and health standards and all rules, regulations and orders issued pursuant to this Act which are applicable to his own actions and conduct.

OSHA Regulations

Current OSHA regulations state in part: “At the time of initial assignment and at least annually thereafter, the employer shall instruct every employee in the safe operation and servicing of all equipment with which the employee is, or will be involved.” These will include (but are not limited to) instructions to:

Keep all guards in place when the machine is in operation;

Permit no riders on equipment;

Stop engine, disconnect the power source, and wait for all machine movement to stop before servicing, adjusting, cleaning or unclogging the equipment, except where the machine must be running to be properly serviced or maintained, in which case the employer shall instruct employees as to all steps and procedures which are necessary to safely service or maintain the equipment.

Make sure everyone is clear of machinery before starting the engine, engaging power, or operating the machine.

EMPLOYEE TRACTOR OPERATING INSTRUCTIONS:

1. Securely fasten your seat belt if the tractor has a ROPS.
2. Where possible, avoid operating the tractor near ditches, embankments, and holes.
3. Reduce speed when turning, crossing slopes, and on rough, slick, or muddy surfaces.
4. Stay off slopes too steep for safe operation.
5. Watch where you are going, especially at row ends, on roads, and around trees.
6. Do not permit others to ride.
7. Operate the tractor smoothly - no jerky turns, starts, or stops.
8. Hitch only to the drawbar and hitch points recommended by tractor manufacturers.
9. When tractor is stopped, set brakes securely and use park lock if available.

Child Labor Under 16 Years Old

Some regulations specify that no one under the age of 16 may operate power machinery. It is your responsibility to know what these regulations are in your own area or situation. (Refer to U.S. Dept. of Labor, Employment Standard Administration, Wage & Home Division, Child Labor Bulletin #102.)

SPECIFICATIONS

	LLR SERIES	MLR SERIES
Rake Width	48", 60", 72", 84"	60", 72", 84", 96"
Rake Height	15"	15"
Hitch Type	Category I	Category I
Tractor HP	35 (Maximum)	50 (Maximum)
Rake Pivot	360°	360°
Pivot King Pin	1-1/4"	1-1/4"
Tine Spacing	1"	1"
Tine Size	5/16 x 1"	5/16 x 1"
Weight (lbs.)	185, 205, 225, 245	305, 325, 345, 365

Figure 1 LLR 60

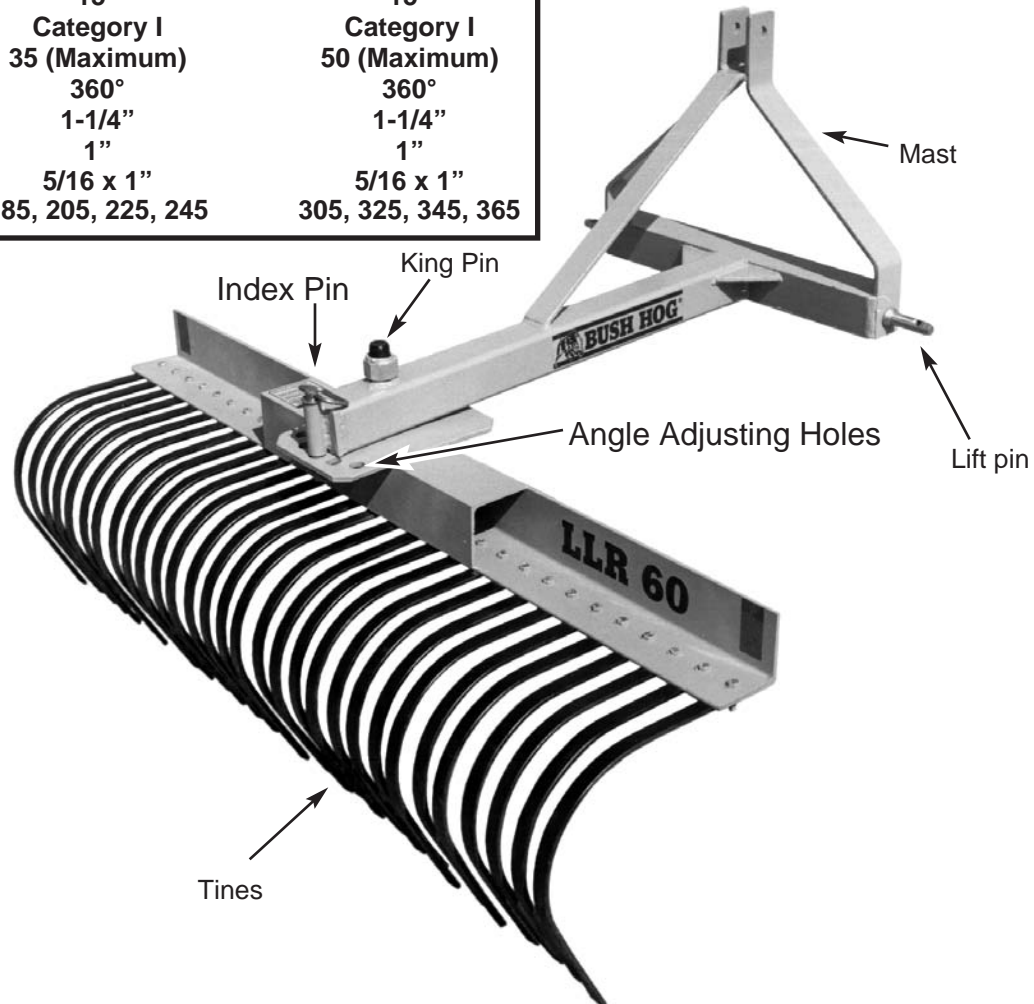

SECTION I OPERATION

⚠ WARNING

DURING RAKE ADJUSTMENT

**KEEP BODY, HANDS AND FEET CLEAR OF RAKE.
KEEP FINGERS CLEAR OF HOLES.**

ATTACHMENT

The rake should be placed on level ground.

Place the tractor rockshaft control in "position control" (non-floating) for attaching and detaching the rear mounted rake. "Draft control" or "position control" can be used while operating.

Back the tractor until the ends of the lift arms can be attached to the lift points on the implement. Secure the lift arms to the mast. (Figure 1)

Attach the center link to the top of the mast and adjust so that the rake frame will be level in the operating position.

DETACHING FROM TRACTOR

Lower the rake to the ground with rockshaft control in position control. Remove top link from mast, disconnect hitch arms from bottom pins and pull tractor away from rake.

⚠ CAUTION

WHEN DETACHING THE RAKE, SUPPORT THE MAST END OF THE BOOM FRAME TO PREVENT IT FROM FALLING. KEEP BODY, HANDS AND FEET CLEAR OF IMPLEMENT.

FIELD ADJUSTMENTS

LLR SERIES - To change the operating angle, remove the index pin and align the frame adjusting hole with one of the five angle settings by pivoting the rake. Reinstall the index pin. (Figure 1)

The rake can also be swiveled to the rear for back raking. Align the frame adjusting hole with the setting for rear raking and replace the index pin. (Figure 1)

MLR SERIES - To change the operating angle, extend, or retract, the ratchet assembly or hydraulic cylinder to achieve the desired angle. (Figure 2)

The rake can also be swiveled to the rear for back raking. Disconnect the ratchet or hydraulic cylinder from the rake frame, pivot the frame 180° and reattach the ratchet or cylinder to the frame.

Care should be exercised during use of the rake to prevent hanging the end tines on immovable objects or otherwise use the implement under conditions beyond its designed capacity.

ing bracket to the frame with 3/8 x 1-1/2" bolts, lockwashers, and nuts.

The height of the gauge wheel can be adjusted by rearranging the spacers above or below the spindle tube to provide the desired height.

⚠ CAUTION

WHEN EQUIPMENT IS TRANSPORTED, USE NECESSARY DEVICES REQUIRED BY LOCAL REGULATIONS FOR ADEQUATE WARNING TO OPERATORS OF OTHER VEHICLES.

⚠ CAUTION

ADDITIONAL TRACTOR FRONT BALLAST MAY BE NEEDED FOR STABLE OPERATION AND TRANSPORT OF IMPLEMENT. SEE TRACTOR OPERATOR'S MANUAL FOR RECOMMENDED WEIGHTS. IT IS RECOMMENDED THAT TRACTOR BE EQUIPPED WITH ROLLOVER PROTECTIVE SYSTEM (ROPS).

Figure 2 MLR 72

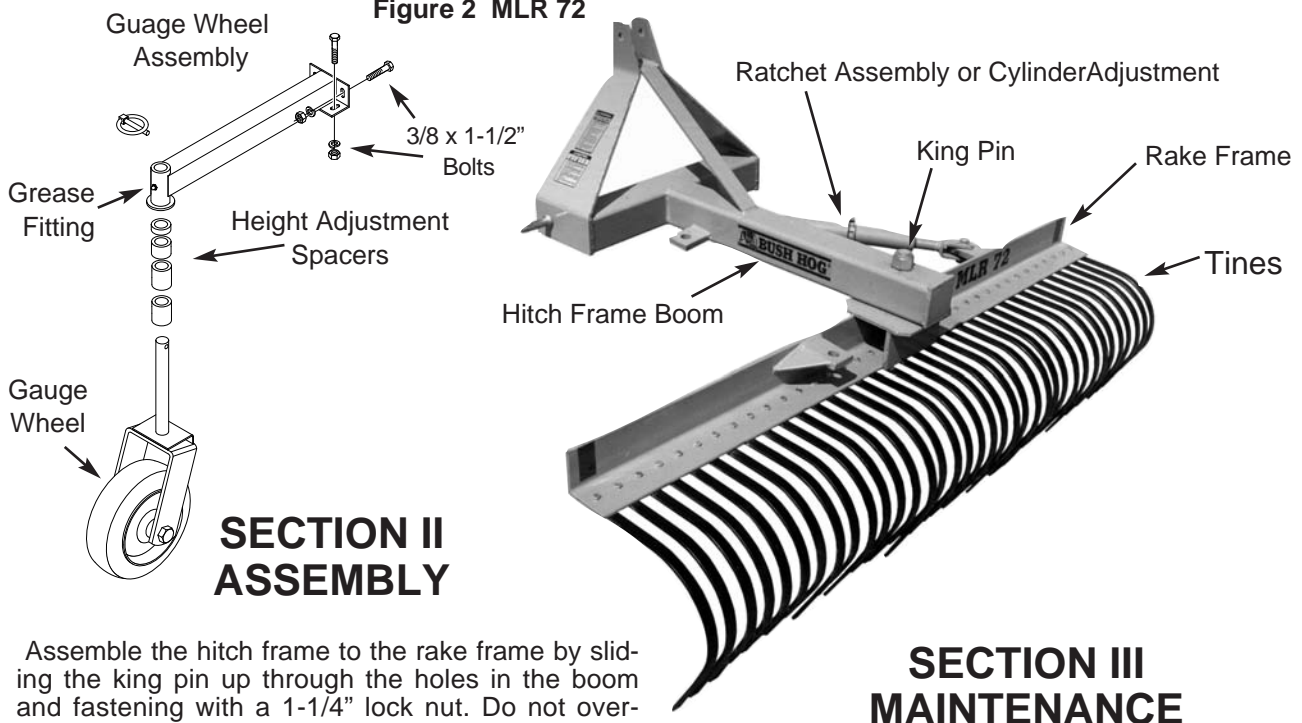

SECTION II ASSEMBLY

Assemble the hitch frame to the rake frame by sliding the king pin up through the holes in the boom and fastening with a 1-1/4" lock nut. Do not over-tighten so as to prevent the rake from pivoting.

Lock the rake frame into desired position with the index pin. Insert presto pin through bottom of index pin. (LLR only)

OPTIONAL GAUGE WHEEL (MLR only) - Remove bolts attaching tines which will be below the gauge wheel mounting bracket.

Position mounting bracket over holes, align tine holes, and fasten with 3/8 x 1-1/2" bolts, lockwashers and nuts. Also fasten the top angle of the moun-

SECTION III MAINTENANCE

Periodically check the hitch pins and insure that the hex nuts are tight.

Store the rake out of the weather when it is not in use. This prevents rusting of the implement.

Inspect your rake periodically and replace any worn or broken parts in order to have your implement ready for use when needed.

Gauge Wheel -Every 40 hours apply multi-purpose grease with grease gun to fitting on spindle tube.

SAFETY DECALS

To promote safe operation, Bush Hog supplies safety decals on all products manufactured. Because damages can occur to safety decals either through shipment, use or reconditioning, Bush Hog will, upon request, provide safety decals for any of our products in the field at no charge. Contact your authorized Bush Hog dealer for more information.

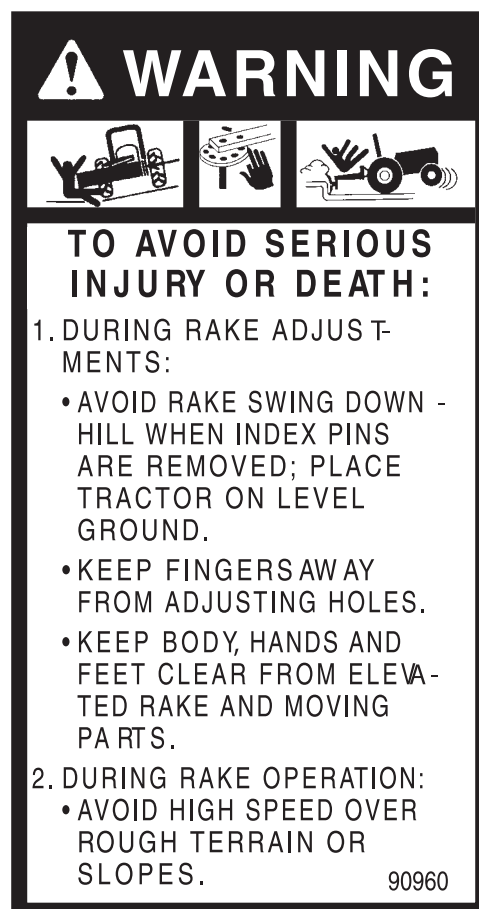

TORQUE SPECIFICATIONS

Proper torque for American fasteners used on Bush Hog equipment.
Recommended Torque in Foot Pounds (Newton Meters).*

AMERICAN

Bolt Head Markings

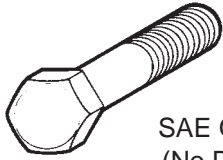

SAE Grade 2
(No Dashes)

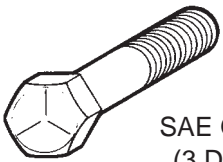

SAE Grade 5
(3 Dashes)

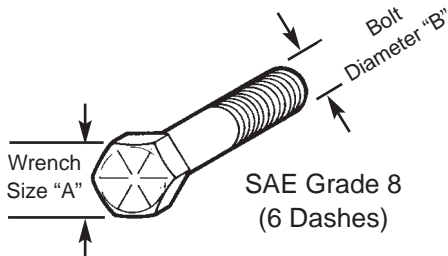

SAE Grade 8
(6 Dashes)

WRENCH SIZE (IN.) "A"	BOLT DIAMETER (IN.) "B" AND THREAD SIZE	SAE GRADE 2	SAE GRADE 5	SAE GRADE 8
7/16	1/4 - 20 UNC	6 (7)	8 (11)	12 (16)
7/16	1/4 - 28 UNF	6 (8)	10 (13)	14 (18)
1/2	5/16 - 18 UNC	11 (15)	17 (23)	25 (33)
1/2	5/16 - 24 UNF	13 (17)	19 (26)	27 (37)
9/16	3/8 - 16 UNC	20 (27)	31 (42)	44 (60)
9/16	3/8 - 24 UNF	23 (31)	35 (47)	49 (66)
5/8	7/16 - 14 UNC	32 (43)	49 (66)	70 (95)
5/8	7/16 - 20 UNF	36 (49)	55 (75)	78 (106)
3/4	1/2 - 13 UNC	49 (66)	76 (103)	106 (144)
3/4	1/2 - 20 UNF	55 (75)	85 (115)	120 (163)
7/8	9/16 - 12 UNC	70 (95)	109 (148)	153 (207)
7/8	9/16 - 18 UNF	79 (107)	122 (165)	172 (233)
15/16	5/8 - 11 UNC	97 (131)	150 (203)	212 (287)
15/16	5/8 - 18 UNF	110 (149)	170 (230)	240 (325)
1-1/8	3/4 - 10 UNC	144 (195)	266 (360)	376 (509)
1-1/8	3/4 - 16 UNF	192 (260)	297 (402)	420 (569)
1-5/16	7/8 - 9 UNC	166 (225)	430 (583)	606 (821)
1-5/16	7/8 - 14 UNF	184 (249)	474 (642)	668 (905)
1-1/2	1 - 8 UNC	250 (339)	644 (873)	909 (1232)
1-1/2	1 - 12 UNF	274 (371)	705 (955)	995 (1348)
1-1/2	1 - 14 UNF	280 (379)	721 (977)	1019 (1381)
1-11/16	1-1/8 - 7 UNC	354 (480)	795 (1077)	1288(1745)
1-11/16	1-1/8 - 12 UNF	397 (538)	890 (1206)	1444 (1957)
1-7/8	1-1/4 - 7 UNC	500 (678)	1120 (1518)	1817 (2462)
1-7/8	1-1/4 - 12 UNF	553 (749)	1241 (1682)	2013 (2728)
2-1/16	1-3/8 - 6 UNC	655 (887)	1470 (1992)	2382 (3228)
2-1/16	1-3/8 - 12 UNF	746 (1011)	1672 (2266)	2712 (3675)
2-1/4	1-1/2 - 6 UNC	870 (1179)	1950 (2642)	3161 (4283)
2-1/4	1-1/2 - 12 UNF	979 (1327)	2194 (2973)	3557 (4820)

METRIC

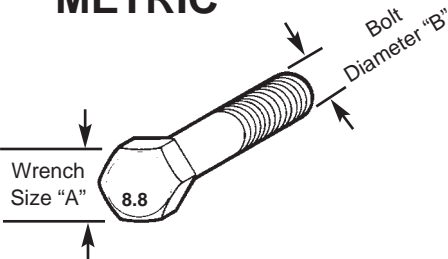

Numbers appearing on bolt heads indicate ASTM class.

Proper torque for metric fasteners used on Bush Hog equipment.
Recommended torque in foot pounds (newton Meters).*

WRENCH SIZE (mm) "A"	BOLT DIA. (mm) "B"	ASTM 4.6	ASTM 8.8	ASTM 9.8	ASTM 10.9
8	5	1.8 (2.4)		5.1 (6.9)	6.5 (8.8)
10	6	3 (4)		8.7 (12)	11.1 (15)
13	8	7.3 (10)		21.1 (29)	27 (37)
16	10	14.5 (20)		42 (57)	53 (72)
18	12	25 (34)	74 (100)	73 (99)	93 (126)
21	14	40 (54)	118 (160)	116 (157)	148 (201)
24	16	62 (84)	167 (226)	181 (245)	230 (312)
30	20	122 (165)	325 (440)		449 (608)
33	22		443 (600)		611 (828)
36	24	211 (286)	563 (763)		778 (1054)
41	27		821 (1112)		1138 (1542)
46	30	418 (566)	1119 (1516)		1547 (2096)

*Use 75% of the specified torque value for plated fasteners. Use 85% of the specified torque values for lubricated fasteners.



BUSH HOG[®]
Performance You Can Count OnSM

P.O. Box 1039 • Selma, AL 36702-1039
Telephone (334) 874-2700 • www.bushhog.com